

Installation Guide

Model: AMAB-0223-D

Dual Monitor Bracket

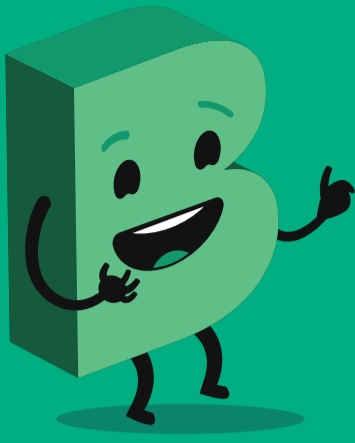

Hey!
Let's get your new monitor
bracket ready to use, fast!

1 Have you got everything?

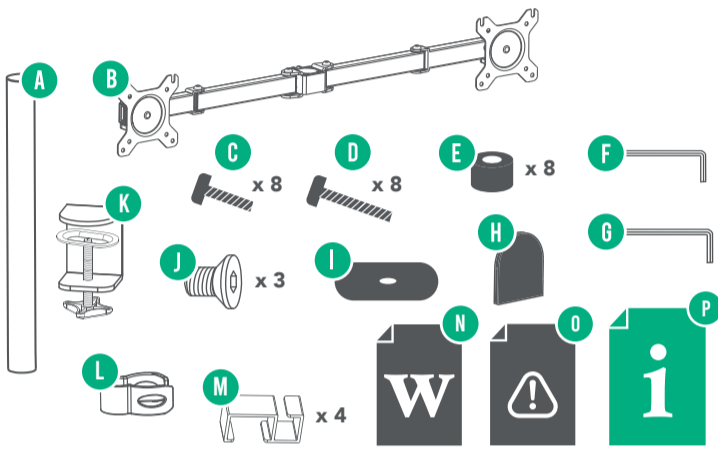

You will also need a Phillips-head screwdriver to secure your monitors to the bracket

Unpack the box (be gentle) and make sure all of these items are there:

- | | | | |
|-------------------------|----------------------|------------------------|--------------------------------|
| A. Pole | E. Screw Spacers (8) | I. Bracket Clamp Cover | M. Monitor Arm Cable Clips (4) |
| B. Monitor Arms | F. 4mm Hex Key | J. Cap Screw (3) | N. Warranty Certificate |
| C. M4 x 8mm Screws (8) | G. 5mm Hex Key | K. Bracket Clamp | O. General Safety Warnings |
| D. M4 x 12mm Screws (8) | H. Pole Cover | L. Pole Cable Clip | P. Installation Guide |

2 Attach to your desk (Mounting to edge of desk)

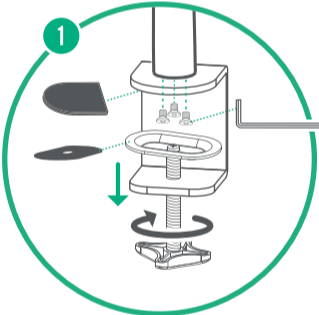

Adhere the bracket clamp cover to the bracket clamp and attach the clamp to the base with the cap screw. Use the 4mm hex key to tighten.

Tighten the bracket clamp from beneath by turning the adjuster clockwise and make sure it's tight. Slide the base cover on and clip into place.

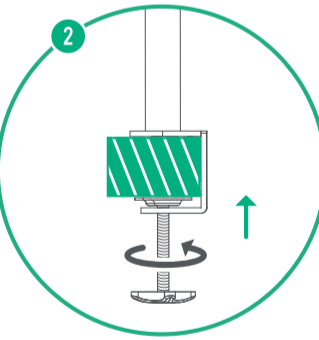

Be careful not to overtighten the clamp or you might cause surface damage to your desk or table

3 Attach the arm

Slide the bracket arms onto the pole. Slide up or down to adjust the height of where your monitors will sit.

Tighten into position at the back, using the supplied 5mm hex key.

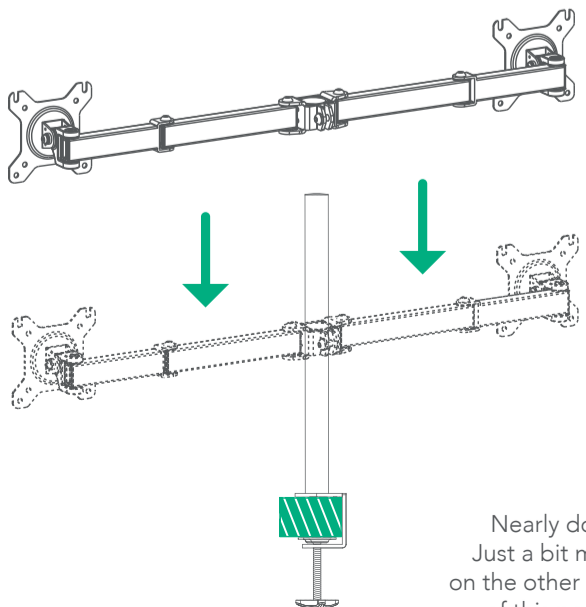
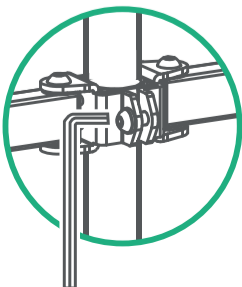

Nearly done!
Just a bit more on the other side of this page...

4 Mount your monitors

1 Install the upper two screws but don't screw them completely just yet. Hang the monitor on the mounting plate.

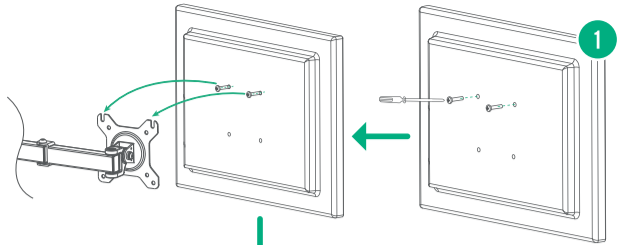

2 Install the lower two screws. Now you can fasten the upper two screws all the way.

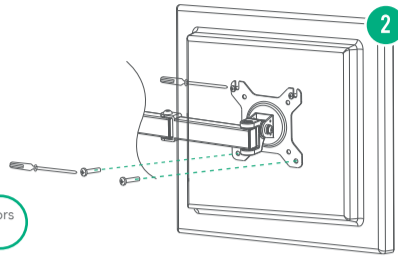

This bracket can handle monitors that weigh 8kg each or less!

5 Adjust to your space

5

It's important to make your workspace as ergonomic as possible.

This bracket allows you to adjust the height, tilt and swivel of your monitor's position, so that it's truly fitted to your space and sitting.

To lock in your adjusted position, you will need to tighten the bolts on the mounting plate and arms using the supplied 5mm hex key.

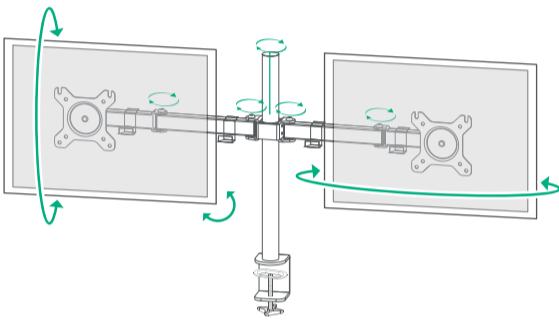

6 Hide those cables

You can tuck away those unsightly cables into the bracket arm itself.

Put the cables through the pole cable clip and monitor arm cable clips as shown in the diagram.

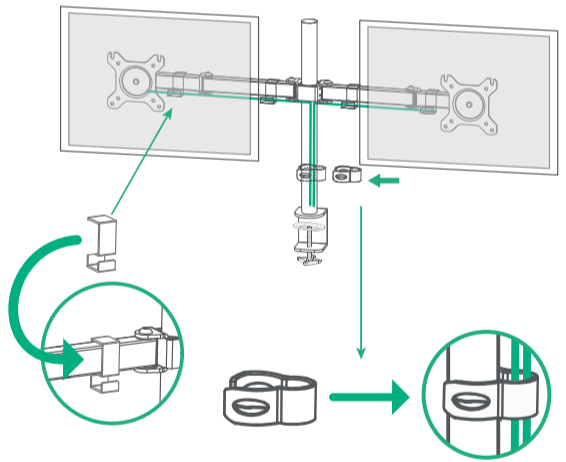

Give us a call



What? You mean this Installation Guide didn't have ALL the answers? Speak to us! We'd love to help you get up and running as quickly as possible. Call our **After Sales Support** on **1300 002 534**.

Operating hours: Monday-Friday, 8:30am-6pm; Saturday, 9am-6pm AEST

Your new Monitor Bracket is ready to enjoy!

Well done, you made it. Now sit back and relax... your new monitor bracket is automatically covered by a 1-year warranty. How nice!

