

BAUHN®
androidtv

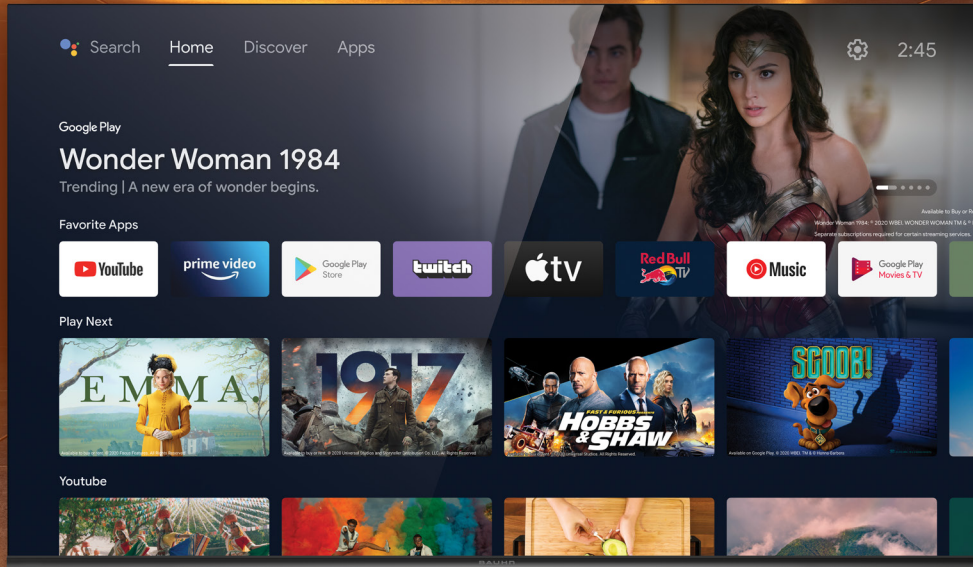

55" **4K**
OLED TV



ATV55UHDQ-0722

User Manual

AFTER SALES SUPPORT

1300 002 534

tempo.org/support

MODEL: ATV55UHDQ-0722 PRODUCT CODE: 709558 07/2022



Welcome

Congratulations on your purchase!

This manual tells you all you need to know about using your new BAUHN® product.

Please take special note of any important safety and usage information presented with the  symbol.

All products brought to you by BAUHN® are manufactured to the highest standards of performance and safety and, as part of our philosophy of customer service and satisfaction, are backed by our comprehensive 1 Year Warranty.

Domestic use only: This product is intended for indoor domestic use only. It is not suitable for commercial, industrial or outdoor use. Do not use this product for anything other than its intended purpose, and only use it as described in this manual.

We hope you will enjoy using your purchase for many years to come.

Contents

Welcome	2	How to play personal videos, photos and music	17	Accessibility	38
Contents	3	How to set up Android TV Remote Control app	18	Restart	38
Unpack and Prepare	4	Smart TV	19	Remote & Accessories	39
What's in the Box	4	Download or Delete Apps	20	High Dynamic Range (HDR)	40
 Important Tips	5	Stream using Chromecast-enabled Apps	21	TV Guide	41
Attaching the Stand	6	Using Voice Interaction	22	Recording	42
Wall-Mounting the TV	7	Connect To Google Home	22	Recording Live TV	43
Connect to Power	8	TV Setting Menus	23	Scheduled Recording	43
Connect your Antenna	8	Picture	25	Playback	43
Controls and Connections	9	Sound	27	Pause Live TV (Time-shift)	44
Get to Know your TV	9	Channel	28	Troubleshooting	45
Buttons on the TV	9	Network & Internet	29	Specifications	48
Ports on the TV	10	Accounts and Sign-in	31	Compliance and Responsible Disposal	49
Remote Control	12	Google Assistant	31	Warranty Information	50
Setup	12	Apps	32	Repair and Refurbished Goods or Parts Notice	51
Using the Remote Control	13	Retail Mode	32		
Remote Pairing	13	About	33		
Remote Overview	14	Date & Time	34		
On-Screen Set Up	16	Inputs	35		
How to access other devices connected to the TV	17	Power	36		
How to turn on/off subtitles in live TV mode	17	Screen Saver	37		
		Location	37		

Unpack and Prepare

What's in the Box

Before installing your new TV, check you have everything needed.

In the box you will find:

- A. 55" 4K QLED Android TV
- B. Remote Control
- C. AAA Activ Energy Batteries
- D. Power Cable
- E. TV Stands
- F. Screws for the TV Stand
- G. Warning Sheet
- H. TV Toppling Safety Message
- I. Quick Start Guide
- J. Warranty Certificate
- K. User Manual
- L. General Safety Warnings

You will need:

- Phillips-head screwdriver (for stand installation)
- Someone to help you lift and install your TV
- Google account
- Internet connection (to access Smart TV apps and functionality)
- Antenna cable (to watch live TV)

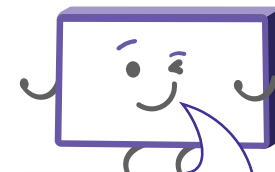

See the box flap for how to handle the TV without damaging it!



Important Tips

- Place the TV on a level surface.
- Place the TV away from any source that may generate heat or vibrations.
- Make sure there is enough space around vents for airflow.
- The remote control works up to 5 metres away from the TV.
- Unplug the TV before cleaning it.
- Clean using a dry cloth only - do not use water or chemicals.
- Use only the power supply provided.
- It is highly recommended to use safety straps for securing the TV in place.
- Keep liquid, children and pets away from the TV at all times.

Attaching the Stand

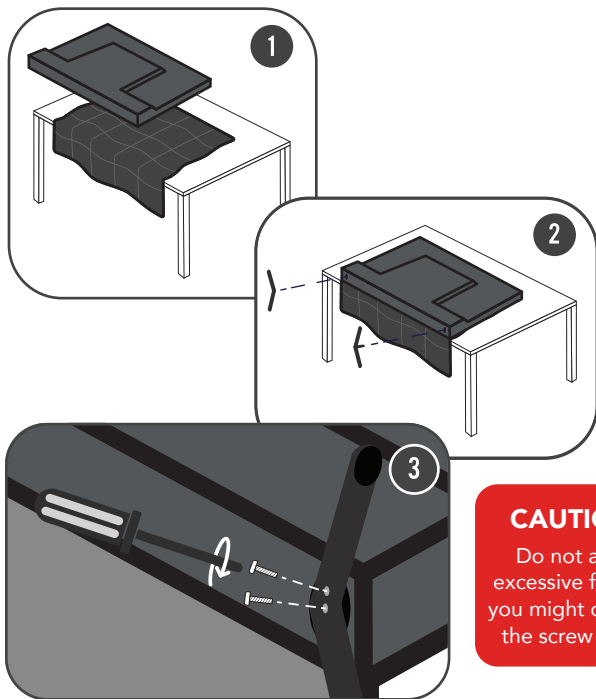

CAUTION!

Do not apply excessive force as you might damage the screw holes.



- Unplug the TV from the power outlet before installing or removing the stand.
- DO NOT place the TV standing upright without its stand attached; it could damage the remote sensor at the bottom of the TV.
- Only touch the frame, not the screen.
- It is highly recommended to use safety straps for securing the TV.

Unless you are wall-mounting the TV, you will need to attach its stand/legs.

1. Lay the TV face-down on a soft, flat surface (like the sofa, or a towel on a table) larger than the TV itself.
2. Match the stands to the installation points on the underside of the TV.
3. Attach the stands to the TV at the installation points using the screws provided. (Grab a screwdriver for this bit).

Wall-Mounting the TV



- Unplug the TV from the power outlet before wall-mounting.
- Contact a professional for assistance with wall-mounting the TV.

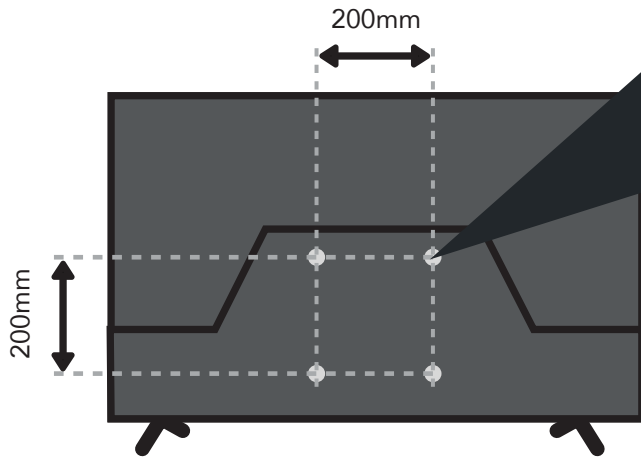

Back of the TV

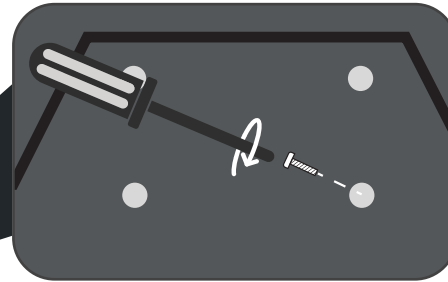

Required

- VESA Mounting Bracket
- 2 x M6*10mm screws (or longer as required)

The TV comes with holes on the back panel for use with wall-mounting brackets (bracket not included).

Use four standard M6*10mm screws (or longer, depending on the mounting bracket) to wall-mount this TV (screws are not included).



The screws in the package are for securing the TV stand only. If you are wall-mounting the TV, consult a qualified installer for advice on bracket support and wall support.

Connect to Power

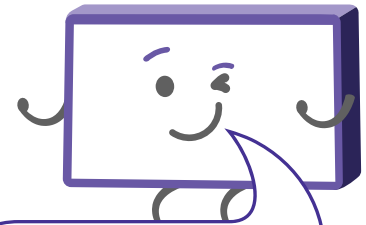
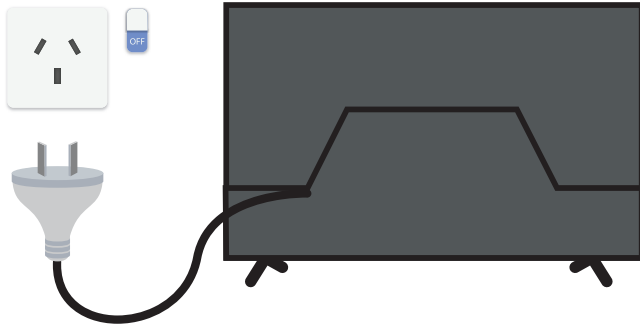

Don't forget to plug in the TV to the power outlet. Leave the power switched off until installation is finished.

! Make sure the TV is **switched off** at the power outlet until you have finished connecting your cables.

Connect your Antenna

Free-to-air TV in HD (High Definition)

Example HD Channels

- ABC HD
- SBS ONE HD
- 7HD
- 9HD
- 10 HD
- PRIME7 HD
- WIN HD

High Definition (HD) channels provide the best viewing quality and are available with a digital antenna connection.

TV channels in Ultra HD resolution are not currently available in Australia. Therefore when you watch HD broadcast signals on an Ultra HD TV, the picture can appear 'soft' and lacks the detail you see when watching the same content on a HD TV.

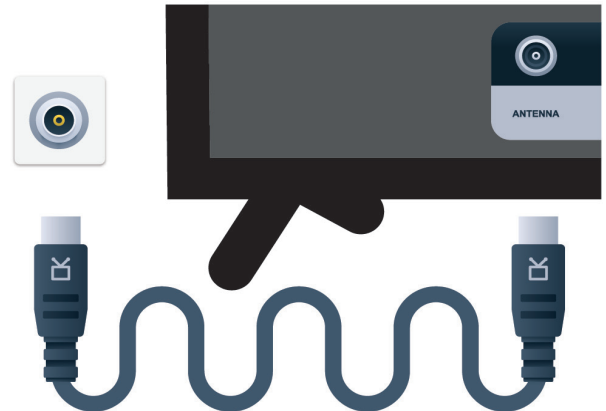

Antenna cable not included.

Controls and Connections

Get to Know your TV

On/Standby light and
Remote sensor

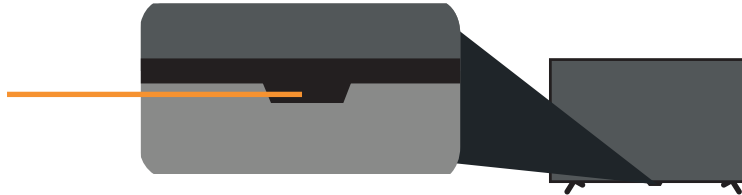

Buttons on the TV



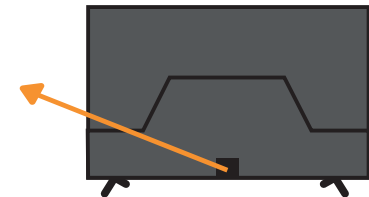



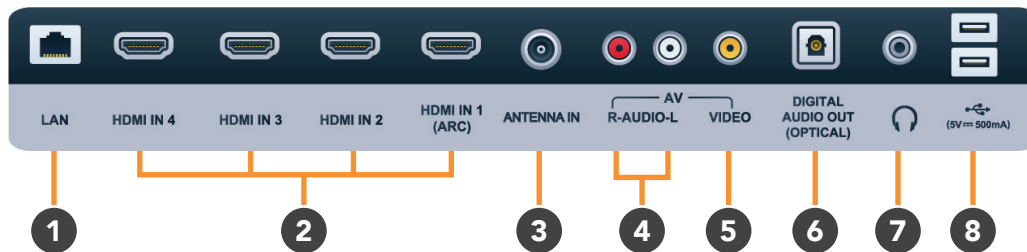
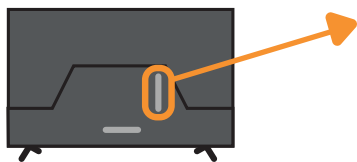

-  /STANDBY: Press the button to turn on the TV. Press and hold the button to turn the TV off.





Rear View

Ports on the TV

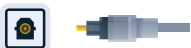

1	LAN	 	INTERNET	Connect to your broadband modem using a network cable (not included) for best streaming experience. However, the TV also has built-in WiFi.
2	HDMI IN	 	SOUND PICTURE COMPUTER	All-digital connection between the TV and any HDMI device. Supports Ultra HD resolution. Requires a high-speed HDMI cable (not included). <i>Use a high-speed HDMI cable for best picture and sound quality.</i>
3	ANTENNA IN	 	FREE-TO-AIR TV	Connect your antenna for live TV. (Antenna cable not included).
4	AUDIO IN	 	SOUND	You can use this to connect Audio to your TV for AV or Component video inputs. Requires an AV cable (not included).

5	VIDEO IN		PICTURE	You can use this to connect your DVD player. Supports Standard Definition (SD) picture quality. Requires an AV cable (not included).
6	DIGITAL AUDIO OUT (OPTICAL)		SOUND	Connect an external digital audio device. Use an Optical cable (not included) to connect the unit with an amplifier, soundbar or other audio decoding device for digital audio signal output.
7	Headphone Jack		SOUND	Connect to your headphones, amplifier, soundbar or audio device, using an AUX cable (not included).
8	USB		STORAGE	<ul style="list-style-type: none"> • Plug in a USB stick to PVR record and pause live TV. • Play media files stored on your USB storage device (supported file codecs and extensions may vary). • Update the TV software via USB.



Remote Control

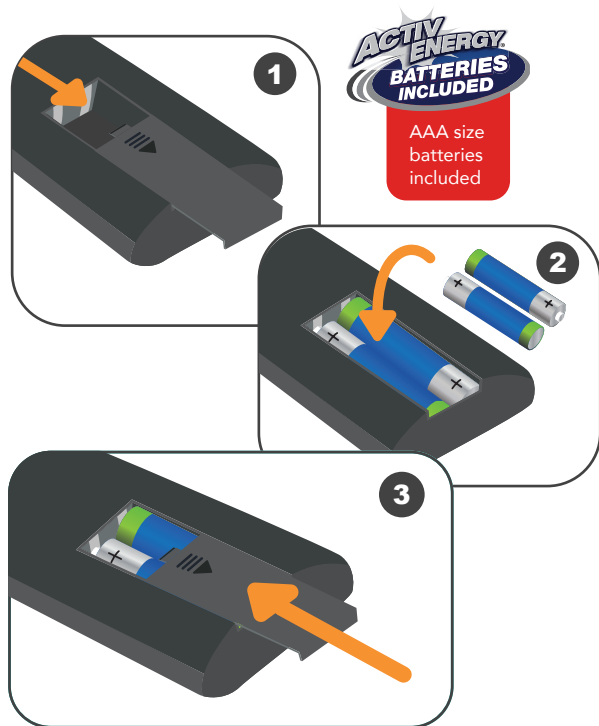

Image is for illustration purposes only.
Position of battery cover/clip and polarities of batteries on
your remote control may vary.

Setup

Insert two AAA size batteries according to the polarity markings (+ / -) inside the compartment. Make sure the batteries are correctly aligned and properly pushed into place.



Precautions When Using Batteries

- Do not use old and new batteries together.
- Do not use different types of batteries (e.g. Manganese and Alkaline batteries) together.
- Remove the batteries from the remote if you do not intend to use it for a long time.
- When discarding used batteries, follow any guidelines for recycling and disposal of batteries that apply in your local area.
- Keep batteries away from children and pets.
- Never throw batteries into a fire or expose them to extreme heat.

Using the Remote Control

To use the remote, point it towards the remote sensor at the front of the TV. The remote will not operate if its path is blocked.

The remote has a range of up to about 5 metres from the TV at an angle of up to 30 degrees to either side of the sensor, as illustrated below.

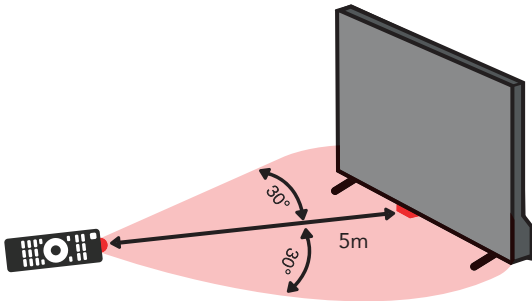

Image is an example only.
Remote sensor location on your TV may vary.



Remote Hints and Tips

- Do not drop, step on or otherwise impact the remote control. This may damage the parts or lead to malfunction.
- Do not place objects between the remote control and the remote sensor.
- Do not use this remote control while simultaneously operating a remote control for other devices.

Remote Pairing

This remote control uses both Bluetooth® and IR (infrared) to send its commands to the TV.

- You can use this remote control via IR for most operations.
- To use advanced operations like voice search, you need to pair the TV with the remote control. During the First Time Setup process, follow the on-screen instructions to pair the remote. Alternatively, go to Settings > Remote & Accessories and follow the on-screen instructions to pair the remote.

Remote Overview



 : Switch the TV to On or Standby

NUMBER BUTTONS (0-9) : Press to select a TV channel directly when watching TV

INFO : Display additional information

 : Display system settings

 : Press the **UP/DOWN/LEFT/RIGHT** buttons to navigate

OK: Confirm your selection; access live TV Channel list

 : Return to the previous screen

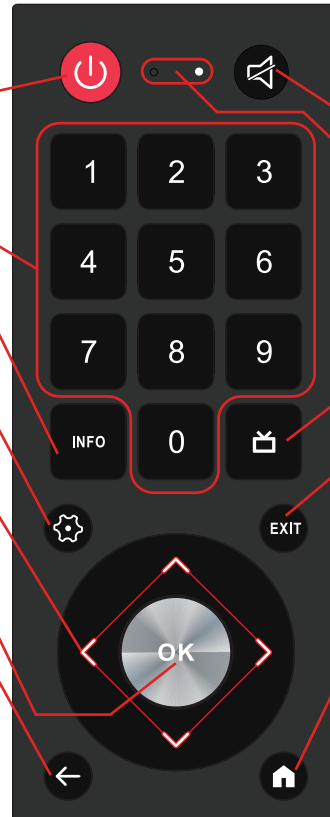

 **(MUTE)** : Mute or restore sound

 : Microphone (lights up when active)

 : Launch the TV guide

EXIT : Quick current interface

 : Android TV home screen



NETFLIX : Launch the Netflix app

prime video : Launch Prime Video app

(Google Assistant) : Summon the Google Assistant

+ / - : Turn the volume up or down

USB: Enter USB mode

[Teletext] : Teletext (not available in Australia)

[Pause] : Pause

[Play] : Play

[Rewind] : Rewind

[Previous] : Play previous selection

RED/GREEN/YELLOW/BLUE BUTTONS: Functions are according to the on-screen display

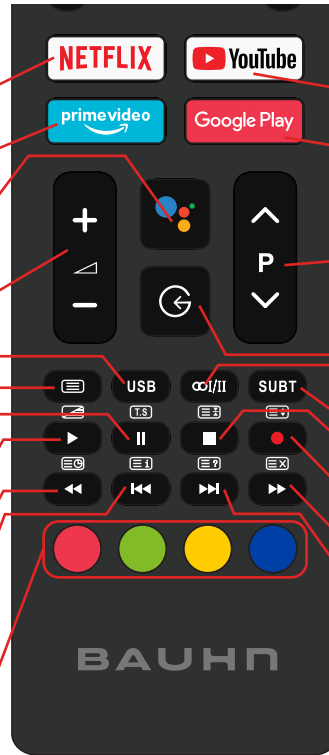

NETFLIX

YouTube

prime video

Google Play

+

[Google Assistant]

^

-

[Source]

P

USB

[Teletext]

[Sound]

[Teletext]

[Pause]

[Subtitles]

[Play]

[Stop]

[Record]

[Rewind]

[Previous]

[Fast Forward]

[Previous]

[Next]

[Next]

[Red]

[Green]

[Yellow]

[Blue]

BAUHN

YouTube : Launch the YouTube app

Google Play : Launch Google Play store

^ P v : Go to the next or previous channel

[Source] : Switch between input signal sources

[Sound] : switch between preset sound modes

SUBTITLE : Display or hide subtitles

[Stop]

(REC) : Record a TV program

[Fast Forward]

[Next] : Play next selection



On-Screen Set Up



Make sure equipment is properly connected (as shown on page 10-11) before connecting the TV to power.

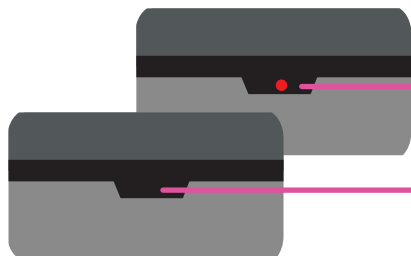

On/Standby light is RED in standby mode.

On/Standby light is OFF when the TV is on.

First Time Setup Menu

When you turn the TV on for the first time, the First Time Setup Menu will appear.

Follow the prompts using the **^** / **v** / **<** / **>** / **OK** buttons to select your preferences. You will be guided through:

- 1. Language
- 2. Location
- 3. Remote Pairing
- 4. Quick Setup
- 5. WiFi Setup
- 6. Terms Of Service
- 7. Google Service
- 8. Google Assistant
- 9. Password
- 10. Select TV Mode
- 11. Chromecast built-in always available
- 12. Channel Scan

If you make an error, you can update your preferences in the settings menu later.

3. Remote Pairing

1. Press and hold the **←** and **—** buttons at the same time for 3 seconds and let go when the indicator light on the remote flashes.
2. When "TVC0GWB T" appears on the top-right corner of the screen, press the OK button to initiate pairing. Once paired, screen will automatically go to the next step.
3. If pairing was unsuccessful, wait 30 seconds and try again.

Note: Don't worry if you fail to pair the remote, you can still go through the setup process and pair the remote later by going to Settings > Remote & Accessories.

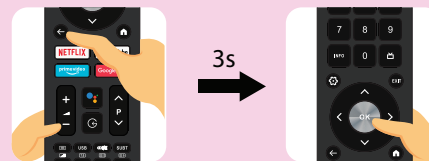



4. Quick Setup

NOTE: To use your Android TV, you will need a Google Account.

There are 3 options to set up your TV:

1. Quick Start using an Android phone: Your Android TV will automatically connect to the Wi-Fi network and Google account that the Android phone is connected to.
2. Set up with your remote: Use the remote to manually enter Google account and connect to Wi-Fi.
3. Set up with a phone or computer: Make sure your phone or computer is on the same Wi-Fi network as the TV is connecting to.

How to access other devices connected to the TV

1. Press the  button on the remote control, select your desired input sources and press OK.
2. (OR) select the  icon from the Android TV home screen.

You can rename the inputs to easily identify the device connected to it by going to:

Settings > Device Preferences > Inputs

How to turn on/off subtitles in live TV mode

1. To turn off subtitles, press the **SUBT** button on the remote, select Digital Subtitle Language Setting and set the option to 'Off.'
2. To turn on subtitles, press the **SUBT** button on the remote, select Digital Subtitle Language Setting and set the option to 'English.'

How to play personal videos, photos and music

You can view your photos or play your music and videos from a connected USB flash drive.

1. Plug in a USB flash drive to one of the USB connections (supports only FAT32 format).
2. Press the **USB** button and select the MMP (Multi-Media Player) app from the favourite apps list and press OK.

Alternatively, you may use other apps available on the Google Play Store.



How to set up Android TV Remote Control app

You can navigate your Android TV using your phone or tablet with the Android TV Remote Control app.

Note: You need an Android device running Android 4.3 or higher to use the app.

1. On your smart phone, search and download the Android TV Remote Control app from the Play Store/App store (alternatively, scan the QR code below):



For Android



For iOS

2. After app has downloaded and installed, open up the app . Ensure that both your smart phone and Android TV are using the same Wi-Fi network.
3. Tap the name of your Android TV.
4. A PIN will appear on your TV screen, enter the PIN on your smart phone and tap Pair.

You can now use your smart phone as a remote for your Android TV.

Smart TV

Before you start using apps, your TV must be connected to the internet.

The speed of your internet connection determines the quality of your audio/video experience when you watch streaming content.

Accessing internet content may count towards your download limit and may incur fees from third parties such as your internet service provider (ISP).

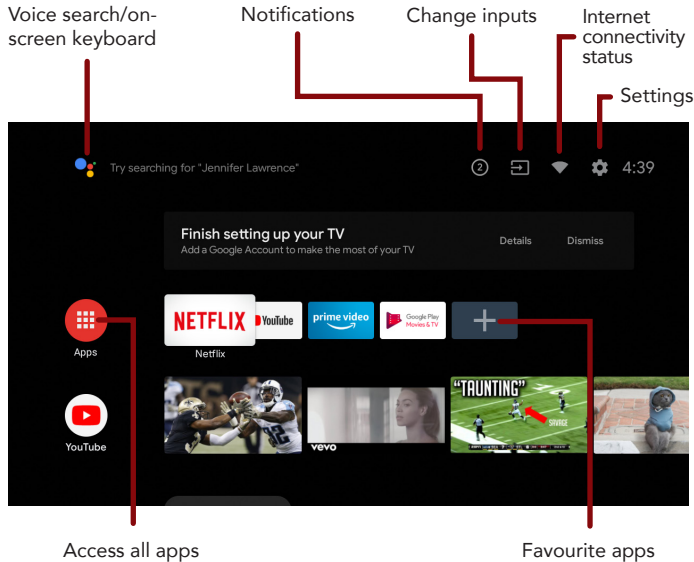

Function

Remote Button

Display the Android TV home screen



Change the order of apps / remove an app from favourites

Press and hold **OK**

Open your desired App

OK

NETFLIX

Netflix is a streaming service that offers unlimited viewing of a wide variety of award-winning TV shows, movies and documentaries.

A paid subscription is required.

This TV can play Netflix content in Ultra HD resolution, however the playback resolution may be lower depending on your subscription level and your network speed.

Streaming Netflix content will count towards the data usage of your broadband plan.

Download or Delete Apps

You can download apps and games for your Android TV through the Google Play Store app.

Download apps

1. From the Android TV Home screen, Select the Google Play Store app.
2. Browse or search for apps and games.

To browse: Move up or down to view different categories. When you find a category you're interested in, move to the right to view items.

To search: To speak your search, scroll to the top of the screen and select the  icon.

To type your search, scroll to the right at the top of the screen and select Input .



3. Select the app or game you want.
4. Select Install.

Delete an app

1. From the Android TV Home screen, select Settings.
2. Select Apps.
3. Under "Recently Opened Apps" or "See All Apps", choose the app you want to remove.
4. Select Uninstall and then press OK.

Stream using Chromecast-enabled Apps

With chromecast built-in, you can cast content from chromecast-enabled apps and chrome browser on your phones, tablets or laptops to your TV. Make sure to turn "Chromecast built-in always available" to On during the first time setup process.

1. Connect your device to the same Wi-Fi network as this TV.
 2. Open the app that has the content you want to cast.
 3. In the app, find and select the  icon.
 4. In the app, select the name of your TV.
 5. When the  icon changes colour, you have successfully connected.
- To stop casting, select the  icon on your device and select Disconnect.



Using Voice Interaction

Your TV remote has a built-in microphone. To enable Google Assistant, you must pair the remote control with the TV which should have been completed during the initial TV setup. If the remote is not paired, see page 39 for pairing instructions.

- To get help from the Google Assistant, ensure that:
 - Your TV is connected to the internet
 - You have signed into your Google account.
- Press the  button on your remote to get started.
- At the bottom of your TV screen, an introduction will appear. When 4 dots appear, speak into the remote's microphone. You can ask your Google Assistant for info and play videos from YouTube, etc.
- For ideas about what your Assistant can help with, ask "What can you do?"
- Download the Google Assistant app on your iPhone, iPad or Android smart device to customise your Google Assistant experience.

Connect To Google Home

Use your voice to control all Google Assistant-enabled smart devices in your home such as cast videos to your Android TV, stream music to a wireless speaker, turn on/off smart power switches and much more.





To get started, get the Google Home app from your favourite app store. Sign in to your Google account, the same one that you used to sign in to the TV.

Proceed to add your devices. Your Android TV "AI PONT" should already be there. Make sure to set it up as your default display device.

TV Setting Menus

Menu Navigation Buttons

See the guide below for all the other buttons you'll need to use to adjust and change your settings.

Function	Remote Button
Display the main menu	
Enter a sub menu	OK
Select an option	
Adjust a value	
Return to the previous menu	

Menu Index

Picture 25

- Picture Mode
- User Mode Settings:
 - Backlight, Brightness, Contrast, Saturation, Hue, Sharpness
- Gamma
- Colour Temperature
- Advanced Video
 - DNR (Digital Noise Reduction), MPEG NR (SDR TO HDR), Adaptive Luma Control, DI Film Mode, Game Mode, PC Mode, HDMI RGB Range
- Colour Tuner
- Reset To Default

Sound 27

- Sound Style
- Balance
- Sound Surround
- Equalizer Detail
- Speakers
- Digital Output

<ul style="list-style-type: none"> • SPDIF Delay • Auto Volume Control • Downmix Mode • Reset to Default 	
Channel	28
<ul style="list-style-type: none"> • Channel Scan • Single RF Scan • Channel Skip • Channel Edit • Parental Controls 	
Network & Internet	29
<ul style="list-style-type: none"> • Wireless Network Settings <ul style="list-style-type: none"> • Wi-Fi • Available Networks • Add New Network • Wired Network Settings <ul style="list-style-type: none"> • Proxy Settings • IP Settings • Other Options <ul style="list-style-type: none"> • WOW (Wake on Wireless Network) • WOL (Wake On Lan) 	
Accounts and Sign-in	31
<ul style="list-style-type: none"> • Add Account • Choose Synced Apps • Remove Account • Sync Now 	

Google Assistant	31
<ul style="list-style-type: none"> • Searchable Apps • SafeSearch Filter 	

Apps	32
<ul style="list-style-type: none"> • Recently Opened Apps • See All Apps • App Permissions • Special App Access • Security & Restrictions 	

Retail Mode	32
--------------------	-----------

About	33
<ul style="list-style-type: none"> • System Update • Factory Reset • Status • Legal Information • Android TV OS Version • Software Version 	

Date & Time	34
<ul style="list-style-type: none"> • Automatic Date & Time • Set Date • Set Time • Set Time-Zone • Use 24-hour Format 	

Inputs	35
<ul style="list-style-type: none"> • Inputs • HDMI Control 	

<ul style="list-style-type: none"> • Device Auto Power Off • TV Auto Power On • CEC Device List 	
--	--

Power	36
<ul style="list-style-type: none"> • Sleep Timer • Picture Off • Switch Off Timer • No Signal Auto Power Off 	

Screen Saver	37
<ul style="list-style-type: none"> • Screen Saver • When To Start • Put Device To Sleep • Start Now 	

Location	37
<ul style="list-style-type: none"> • Location Status • Recent Location Requests 	

Accessibility	38
<ul style="list-style-type: none"> • Audio Description • Spoken Subtitle • Captions • High Contrast Text 	

Restart	38
----------------	-----------

Remotes & Accessories	39
----------------------------------	-----------

High Dynamic Range (HDR)	40
---------------------------------	-----------

Picture

To access picture settings, navigate from Settings > Device Preferences > Picture

Picture Mode

Standard : Settings are optimised for viewing in brightly-lit environments such as store-fronts.

Vivid : Enhanced brightness with lower contrast, colour depth and edges for standing out in very bright places such as storefronts.

Sport : Settings are optimised for watching sports.

Movie : Settings are optimised for viewing movies.

Game : Settings are optimised for gaming.

Energy Saving : Settings are optimised for minimal power consumption.

User : Adjust settings to best suit your viewing environment and content.

User Mode settings

Option	Description
Backlight	Adjust the screen brightness by adjusting the backlight. The closer to 100, the brighter the screen.
Brightness	Adjust the overall screen brightness. The closer to 100, the brighter the picture.
Contrast	Adjust the contrast of the bright and dark areas of the picture. The closer to 100, the higher the contrast.
Saturation	Adjust the intensity of the colours. The closer to 100, the deeper the colour.
Hue	Adjust the hue of the picture between red and green tints.
Sharpness	Adjust the sharpness of the picture. The closer to 20, the sharper and clearer the image.



When you adjust backlight/brightness/contrast/saturation/hue/sharpness settings, they get automatically saved under user mode.



Gamma

Adjust the mid level brightness of the picture.

Colour Temperature

Adjust the on-screen colour temperature.

In user mode, you can individually adjust white balance by changing R/G/B gain settings.

Advanced Video

See the table for more information.

Colour Tuner

Tune the picture quality.

11 Point White Balance Correction

Adjust the white balance calibration.

Reset to Default

Reset all Picture settings to factory defaults.

Advanced Video

Option	Description
DNR (Digital Noise Reduction)	Reduce screen noise to make the image clean.

Option	Description
MPEG NR (SDR TO HDR)	Reduces the noise produced during the creation of digital video signals. Turn HDR on/off.
Adaptive Luma Control	Automatically adjusts the brightness and contrast after analyzing the input signal.
Local contrast Control	Choose local contrast model
DI Film Mode	Set the DI (De-Interlace) film mode on/off.
Blue Stretch	Switch the Blue Stretch on/off.
Game Mode	Enhances your gaming experience by reducing game controller delay.
ALLM	Auto Low-Latency Mode
PC Mode	When connecting to a PC via HDMI.
De-Counter	Used to cut relatively thin contour lines
MJC	Motion plus frame processing technology
HDMI RGB Range	When connecting to a PC via HDMI, select either Auto/Fill/Limit according to the input picture RGB range.
Low Blue Light	Select the Low Blue Light on/off.

Sound

To access sound settings, navigate from Settings > Device Preferences > Sound

Option	Description
Sound Style	Select your preferred sound mode. User Standard Movie Music News Vivid Sports Auto
Balance	Adjust the balance between the left and right speakers.
Bass	Adjust the bass
Treble	Adjust the treble
Sound Surround	Turn surround sound effect On/Off.
Equalizer Detail	Adjust equalizer detail frequencies to your liking.
Speakers	Select which speakers the TV uses for audio output.
Speaker Delay	Adjust the speaker delay time.
eARC	Enhanced Audio Return Channel
Digital Output	Select the digital audio output mode. Options: Auto, Bypass, PCM, Dolby Digital Plus, Dolby Digital.
SPDIF Delay	Synchronize the sound from an external home theatre system with the TV picture.
Auto Volume Control	Turn on to set volume to be consistent across programs and channels automatically.
Downmix Mode	Select audio mode. Options: Stereo, Surround
Dolby Audio Processing	Switch the Dolby Audio Processing on/off or choose the sound model.
Reset to Default	Reset all audio settings to factory defaults.

Channel

To access channel settings, navigate from Settings > Channel

Option	Description
Channels > Channel Scan	Automatically scan DTV channels.
Channels > Single RF Scan	Manually scan DTV channels one frequency at a time.
Channels > Channel Skip	Hide channels from the channels list.
Channels > Channel Edit	Delete channels from the channels list.
Parental Controls	Set parental controls for DTV channels.

Network & Internet

To access network settings, navigate from Settings > Network & Internet

You can set up your TV so that it can access the Internet through your home network using a wired or wireless connection.

When you connect an ethernet cable, the TV automatically accesses the Internet.

Wireless Network Settings

Make sure that you have the wireless router's SSID (name) and password settings before attempting to connect.

Option	Description
Wi-Fi	Switch Wireless connectivity On/Off.
Available Networks	Select a wireless network to connect to.
Add New Network	Manually connect to a Wi-Fi network by entering the name of the Wi-Fi network and password.

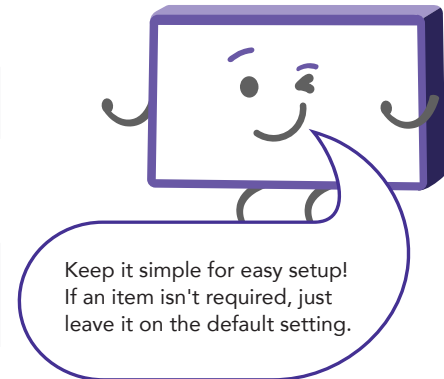

Wired Network Settings

Option	Description
Not connected	Display the network once connection is successful.
Proxy settings	Manually setup proxy settings.
IP settings	DHCP: The TV will automatically connect to the network. Static: Manually assign network settings.



Make sure you have an ethernet cable connected to the TV

Other Options

Option	Description
WOW (Wake on Wireless Network)	Turn WOW on/off.
WOL (Wake on LAN)	Turn WOL on/off.

Accounts and Sign-in

To manage account settings, navigate from Settings > Accounts & Sign-in and click on the account

Option	Description
Add Account	Add your Google account to your TV.
Choose Synced Apps	Manage which apps are synced with your Google account.
Remove Account	Remove your Google account from your TV.
Sync Now	Sync your Google account to your TV.

Google Assistant

To access Google Assistant settings, navigate from Settings > Device Preferences > Google Assistant

Option	Description
Searchable Apps	Select which apps to include in search results.
SafeSearch Filter	Enable or Disable SafeSearch filter.



Apps

To access app settings, navigate from Settings > Apps

Option	Description
Recently Opened Apps	Displays your most recently opened apps.
See All Apps	View all installed apps on your TV.
App Permissions	Set app permissions for your installed apps.
Special App Access	Modify the APP access settings.
Security & Restrictions	Control installation of apps from unknown sources and disallow/warn before installation of apps that may cause harm.

Retail Mode

Turn retail mode on/off, go to Settings > Device Preferences > Retail Mode

About

To access about settings, navigate from Settings > Device Preferences > About

Option	Description
System Update	Check if a system software update is available.
Factory Reset	Reset your TV to factory default settings.
Status	View information on IP address, MAC address, Bluetooth® address
Legal Information	Read up on legal notices and opt out of personalised ads.
Android TV OS Version	View Android version.
Software Version	View TV software information.



Date & Time

To access date & time settings, navigate from Settings > Device Preferences > Date & Time

Option	Description
Automatic Date & Time	Use network provided date and time or enable setting update and time manually.
Set Date	Manually set the date.
Set Time	Manually set the time.
Set Time-Zone	Set your time zone.
Use 24-hour Format	Turn On/Off 24 hour time display.

Inputs

To access input settings, navigate from Settings > Device Preferences > Inputs

Option	Description
Inputs	Select the input source to customize the input name.
HDMI Control	Allow your TV remote to control other devices (that support CEC) connected via HDMI.
Device Auto Power Off	Power off connected HDMI devices when you switch off your TV.
TV Auto Power On	Power on connected HDMI devices when you switch on your TV.
HDMI EDID Version	Displays current HDMI EDID Version.
CEC Device List	Show a list of connected devices that supported CEC (Consumer Electronic Control).



Power

To access power settings, navigate from Settings > Device Preferences > Power

Option	Description
Sleep Timer	Select the desired Auto Sleep (Standby) duration.
Picture Off	Turn off the screen while sound continues. Press the OK button to turn on the screen again.
Switch Off Timer	Set the switch off timer.
No-Signal Auto Power Off	If there's no input signal nor press-button operation, the TV will enter standby status.
Auto Sleep	Choose Auto Sleep time or switch off.

Screen Saver

To access screen saver settings, navigate from Settings > Device Preferences > Screen Saver

Option	Description
Screen Saver	Set the screen saver mode.
When To Start	Set the screen saver start time.
Start Now	Select to instantly start the screen saver.

Location

To access location settings, navigate from Settings > Device Preferences > Location

Option	Description
Location Status	Select how location is estimated.
Recent Location Requests	View location requests by apps.



Accessibility

To access accessibility settings, navigate from Settings > Device Preferences > Accessibility

Option	Description
Audio Type	Choose a different audio type.
Captions	Enable closed captions, to see audio as text on the screen.
High Contrast Text	Turn high contrast text On/Off.

Restart

To access reset settings, navigate from Settings > Device Preferences > Restart to reset the TV to factory shipping condition and reboot.

Remote & Accessories

To access remote and accessories settings, navigate from Settings > Remote & Accessories

In this menu, you can pair Bluetooth® speakers, keyboards and other devices.

To pair the TV remote:

1. Press the ← and — buttons for 3 seconds and release when the indicator light on the remote flashes.
2. When "TVC0GWBT" appears on the top right corner of the screen, select the name and press the **OK** button to initiate pairing.
3. If the pairing is unsuccessful, please wait 30 seconds and try again.
4. Press the ← button to return to the previous menu.

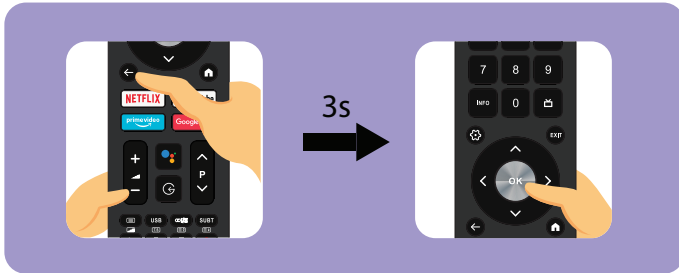

- When pairing the devices to the TV, ensure they are in Bluetooth® pairing mode and are in close proximity to the TV.
- To ensure connection is successful, power on the Bluetooth® paired device before the TV and the TV will automatically reconnect to the Bluetooth® paired device.

Note: the distance between the remote control and TV must be less than 20cm.

High Dynamic Range (HDR)



About the HDR feature

High Dynamic Range (HDR) is a picture feature on your TV that attempts to mimic the way visuals are perceived in real life by the human eye.

By using this feature, this TV can reproduce greater dynamic range of luminosity by capturing and then combining several different exposures.

HDR promises better picture quality thanks to brighter, more realistic highlights, more realistic colour and other improvements.

It delivers the look that the filmmakers intended to achieve, showing the hidden areas of dark shadows and sunlight with full clarity, colour and detail.





HDR on your TV

HDR is supported in HDMI and USB input sources and by Netflix app.

TV Guide

(Free to air TV)

TV Guide Functions

Function	Remote Button
Select a Program	^ / v
Display programs for the next day	 GREEN
Display programs from previous day	 RED
Filter programs by category	 BLUE
Schedule a program to be recorded	
Exit TV Guide menu	←

To access the TV guide, press the  button on the remote.

To activate the TV Channels use the ^ / v buttons to select a channel in the left column, then press **OK** to confirm.

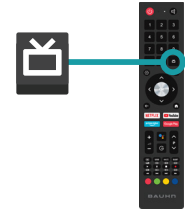

Recording

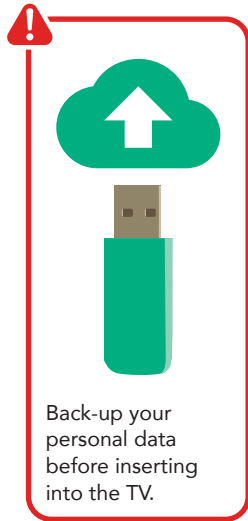

Important Tips:

- Back-up your personal data before plugging in your USB to the TV. We do not assume liability for any loss of data due to misuse or malfunction.
- You cannot change channels while in recording mode.
- If the signal is interrupted while in recording mode, the recording will stop until the signal is established.
- Do not turn the TV off while it is in time-shift mode.
- The file recorded can only be used on this TV. Do not copy it to any other device.
- When connecting or disconnecting the USB storage device, ensure the TV is not in USB mode, otherwise the USB device or the files stored on it may be damaged.
- Ensure the USB storage device is FAT32 format.



Before you can record with this TV (including time-shift recording), you must insert your USB storage device into the USB port.



Recording, scheduled recording and pause live TV functions only work in DTV mode (free-to-air).

Recording Live TV



Start Recording



Press **● (REC)** once to start recording.

Stop Recording

Press **■ (STOP)** once to stop recording.







Scheduled Recording

See TV Guide Functions on page 41 to schedule recordings. View the list of scheduled recordings, press the  button then press the  button to go to the RECORD section then select Schedule List.

Playback



Press the  button then press the  button to go to Record section, and Record List to display the list of recorded programs.

Use the  /  buttons to select a recorded file.

Press the **OK** button to start playback in Full Screen Mode.

Press  **YELLOW** to delete the selected file.



Pause Live TV (Time-shift)

Temporarily pause the live TV signal, then resume playback at your convenience.

Before you can record with this TV (including time-shift recording), you must insert your USB storage device into the USB port.



Enable Time Shift Mode

Press the  button then press the  button to go to the RECORD section. Select Time Shift Mode and press **OK**.

Press **OK** to turn on Time Shift mode and press the  to exit out of the menu.

Press the  button and set up disk for time shift recording.



Recording, scheduled recording and pause live TV functions only work in DTV mode (free-to-air).

Start Time-shift

Press the  button on the remote to enter time-shift mode.

Press the  button to resume playing the program.

Stop Time-shift

Press the  (**STOP**) button to exit time-shift.



The USB storage device won't retain recorded data after you exit the time-shift function.

Troubleshooting

If you experience problems with your TV, check below for advice. If you don't find a solution here, contact After Sales Support on 1300 002 534.

Problem	Solution
The remote control does not work	<ul style="list-style-type: none">Make sure that the batteries are installed with their poles (+/-) in the correct direction.Remove any obstacles between the remote control and remote control sensor on the TV.Check if the power indicator at the bottom of the TV blinks when you press the remote's power button.If it does not, replace the remote control's batteries.Try pointing the remote directly at the remote control sensor from 1.5-1.8m away.
The TV won't turn on	<ul style="list-style-type: none">Make sure that the AC power cord is securely plugged into the wall outlet.Check the wall outlet is turned on and the power indicator at the bottom of the TV is lit.If using a multi-outlet, check if it is working properly. To check whether a power strip is working properly, plug the TV's power plug directly to a wall outlet and observe its operation.Try to power on using the power button on the TV.
There is no picture/sound or distorted picture/sound in DTV mode	<ul style="list-style-type: none">Ensure the antenna cable is securely connected to the TV and to the wall outlet.Ensure the input source is set to DTV.If "No Signal" is displayed, run Settings > Channel > Channels > Channel Scan to search for channels.If some channels are missing, run Settings > Channel > Channels > Channel Scan or manually search by Settings > Channel > Channels > Single RF Scan.Try a different antenna cable or another TV if possible.Move the TV away from electronic equipment or devices that could cause interference.Adjust the antenna position.If the picture appears fuzzy or blurry, select High Definition (HD) channels or programs.



Problem	Solution
<p>There is no picture/sound or distorted picture/sound from an external device</p>	<p>Ensure that connection to the device is correct and that all cables are fully inserted.</p> <p>Remove and reconnect all cables connected to the TV and the external devices. Try new cables if possible.</p> <p>Restart the connected devices by unplugging each device's power cord and then plugging it in again.</p> <p>If "No Signal" is displayed on the TV, ensure that the correct input source has been selected.</p>
<p>There is no/distorted/delayed sound</p>	<p>Ensure the volume is not muted. If it is, press the + button to restore the sound.</p> <p>Check the volume level of the external device.</p> <p>If earphones are connected, unplug them.</p> <p>Ensure that connection to the external audio device is correct and that all cables are fully inserted.</p> <p>Ensure correct input source and audio settings have been selected on the external audio device.</p> <p>Move the TV away from electronic equipment or devices that could cause interference.</p> <p>When using an external audio device via a HDMI cable, ensure that the device supports HDMI-ARC and, if applicable, the CEC setting is turned On (refer to the connection guide in the user manual of the connected device).</p> <p>Adjust the settings as below:</p> <p>Setting > Device Preferences > Inputs > Consumer Electronic Control (CEC) > HDMI Control > On.</p> <p>Setting > Device Preferences > Sound > Speakers > Select "External Audio System" On/off.</p> <p>When using an external audio device via an optical cable, check that the Settings > Device Preferences > Sound > Digital Output is set to "PCM".</p> <p>If the TV is paired to a Bluetooth® speaker, power on the Bluetooth® speaker before the TV to ensure successful connection.</p> <p>If the TV sound is not synchronised with the picture, adjust the applicable Settings > Device Preferences > Sound > SPDIF Delay.</p> <p>If the TV is paired with a Bluetooth® speaker, power on the speaker before the TV and the TV will automatically reconnect to the speaker. If there is still no audio output, manually unpair and pair again.</p>



Problem	Solution
<p>There is no/ intermittent internet</p>	<p>When using Wi-Fi, make sure the Wi-Fi password is entered correctly.</p> <p>Turn off the access point. Wait for 2 minutes and then turn them back on.</p> <p>Ensure that there are no obstacles between the TV and the access point. (The Wi-Fi strength can be decreased by appliances, cordless phones, stone walls/fireplaces, etc.) Reduce interference by not using or turning off other wireless devices.</p> <p>If the Wi-Fi connection fails, connect the TV to the access point via a LAN cable. If the TV can connect via the wired connection, there might be a problem with the Wi-Fi access point. In this case, try using a different access point.</p> <p>When using a LAN cable, use one rated CAT 5 or higher. Make sure it is plugged in at both ends.</p> <p>When using a static IP, ensure network addresses are entered correctly.</p> <p>If the problem persists, contact your Internet Service Provider or modem manufacturer.</p>
<p>USB storage device is not recognised or media files don't play properly</p>	<p>This TV has been tested with the majority of Flash memory-based devices and hard disks (media players with HDD) on the market however, it may not be compatible with certain devices.</p> <p>If the external hard drive has its own power adaptor, use it.</p> <p>Only use a USB storage device formatted in a FAT32 file system provided with the Windows operating system. If it is formatted by a different utility program that is not supported by Windows, it may not be recognised.</p> <p>The TV may not be able to recognise a USB device or read the files if it is connected with a USB extension cable</p> <p>The files that use an unsupported codec or container will not play on the TV.</p> <p>Some files may not play correctly if there is an error in the content or container.</p> <p>Certain files, depending on how they are encoded, may not play on the TV.</p> <p>Sound may not work if they have standard bit rates/frame rates above the TV's compatibility ratings.</p>



Specifications

Active screen size (diagonal)	139cm	
Resolution	3840 x 2160	
Refresh rate	60Hz	
Aspect ratio	16:9	
Multimedia playback formats (USB mode)	Video	AVI, MPEG-1, MPEG-2, MPEG-4
	Music	M4A, OGG, MP3,
	Photo	JPEG, JPG, BMP, PNG, GIF
USB output	DC 5V 500mA	
Power source	AC 100-240V~50/60Hz	

Power consumption	145W	
Dimensions (W x D x H)	With stand: 1226 x 275 x 767 mm	
	Without stand: 1226 x 89 x 710 mm	
Weight	Net	13 kg
	Gross	16.1 kg

For Technical and Warranty Support

1300 002 534

tempo.org/support

Distributed by Tempo (Aust) Pty Ltd,

PO Box 132, Frenchs Forest NSW 1640

Bluetooth®

The Bluetooth® word mark and logos are registered trademarks owned by Bluetooth SIG, Inc., and any use of such marks by Hands (IP) Holdings Pty Ltd is under license. Other trademarks and trade names are those of their respective owners.

Compliance and Responsible Disposal



Packaging

The packaging of your product has been selected from environmentally friendly materials and can usually be recycled. Please ensure these are disposed of correctly. Plastic wrapping can be a suffocation hazard for babies and young children, please ensure all packaging materials are out of reach and are safely disposed of. Please recycle these materials rather than throwing them away.



Product

At the end of its working life, do not throw this product out with your household rubbish.

An environmentally friendly method of disposal will ensure that valuable raw materials can be recycled. Electrical and electronic items contain materials and substances which, if handled or disposed of incorrectly, could potentially be hazardous to the environment and human health.

Compliance

This product complies with the Australian Safety Standard AS/NZS 62368.1 to ensure the safety of the product.



National Television and Computer Recycling Scheme

The careful disposal of e-waste is important because many televisions and computers contain materials which are hazardous to people and the environment. There are no fees for householders or small businesses disposing of e-waste at a scheme collection service.

Individuals can contact their local council for information on local e-waste management services, find scheme services listed on Planet Ark's website at www.recyclingnearyou.com.au, or call Planet Ark on 1300 733 712.

Trademark acknowledgements

Google, Android, Android TV and Google Play are trademarks of Google LLC.





BAUHN®

Warranty Information

The product is guaranteed to be free from defects in workmanship and parts for a period of 12 months from the date of purchase. Defects that occur within this warranty period, under normal use and care, will be repaired, replaced or refunded at our discretion, solely at our option with no charge for parts and labour. The benefits conferred by this warranty are in addition to all rights and remedies in respect of the product that the consumer has under the Competition and Consumer Act 2010 and similar state and territory laws.

Our goods come with guarantees that cannot be excluded under the Australian Consumer Law. You are entitled to a replacement or refund for a major failure and to compensation for any other reasonably foreseeable loss or damage. You are also entitled to have the goods repaired or replaced if the goods fail to be of acceptable quality and the failure does not amount to a major failure.





BAUHN®

Repair and Refurbished Goods or Parts Notice

Unfortunately, sometimes faulty products are manufactured, which need to be returned to the supplier for repair.

Please be aware that if your product is capable of retaining user-generated data (such as files stored on a computer hard drive, telephone numbers stored on a mobile telephone, songs stored on a portable media player, games saved on a games console or files stored on a USB memory stick) during the process of repair, some or all of your stored data may be lost. We recommend you save this data elsewhere prior to sending the product for repair.

You should also be aware that rather than repairing goods, we may replace them with refurbished goods of the same type or use refurbished parts in the repair process.

Please be assured though, refurbished parts or replacements are only used where they meet ALDI's stringent quality specifications.

If at any time you feel your repair is being handled unsatisfactorily, you may escalate your complaint. Please telephone us on 1300 002 534 or write to us at:

Tempo (Aust) Pty Ltd ABN 70 106 100 252
PO Box 132, Frenchs Forest NSW 1640
Telephone: 1300 002 534 (Aust) Fax: (02) 8977 3765
Tempo Help Desk: 1300 002 534 (Aust)
(Operating Hours: Mon-Fri 8:30am-6pm; Sat 9am-6pm AEST)
Email: tempo.org/support

Online support

Visit bauhn.com.au for software updates to keep your TV up-to-date, as well as the latest User Manual for information on the updated features.

Warranty returns

Should you for any reason need to return this product for a warranty claim, make sure to include all accessories with the product.

Product does not work?

If you encounter problems with this product, or if it fails to perform to your expectations, please contact our After Sales Support Centre on 1300 002 534.

ALDI guarantees that our products are developed to our stringent quality specifications. If you are not entirely satisfied with this product, please return it to your nearest ALDI store within 60 days from the date of purchase for a full refund or replacement, or take advantage of our after sales support by calling the supplier's Customer Service Hotline.

