

Installation Guide

Model: AMAB-0622-S

Gas Spring Monitor Bracket with USB ports

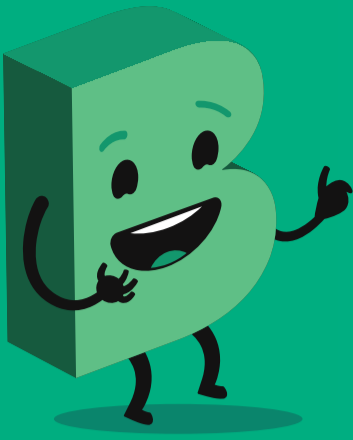

Hey!
Let's get your new monitor bracket ready to use, fast!

1 Have you got everything?

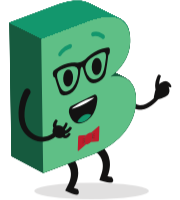
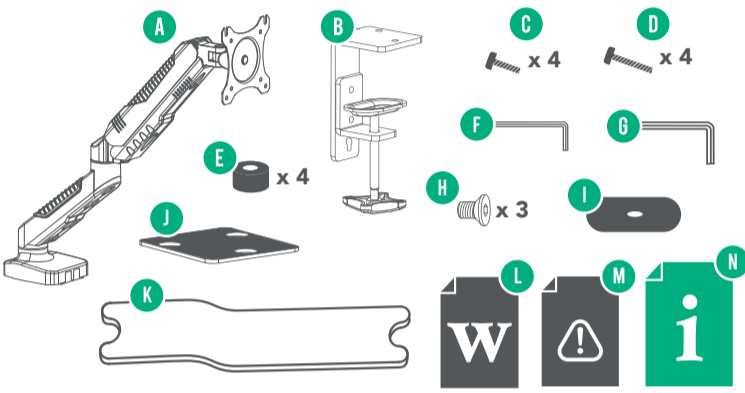

You will also need a Phillips-head screwdriver to secure your monitors to the bracket

Unpack the box (be gentle) and make sure all of these items are there:

- | | | | |
|--|-------------------------|------------------------|----------------------------|
| A. Gas Spring Monitor Bracket with USB ports | D. M4 x 12mm Screws (4) | H. Cap Screws (3) | L. Warranty Certificate |
| B. Bracket Clamp | E. Screw Spacers (4) | I. Bracket Clamp Cover | M. General Safety Warnings |
| C. M4 x 8mm Screws (4) | F. 4mm Hex Key | J. Bracket Cover | N. Installation Guide |
| | G. 5mm Hex Key | K. Cable Cover | |

2 Attach to your desk (Mounting to edge of desk)

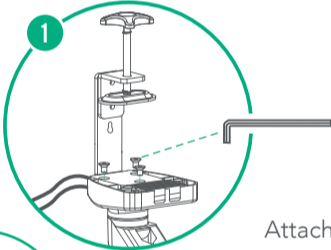

Attach the bracket clamp to the base with the 3 cap screws. Use the 4mm hex key to tighten.

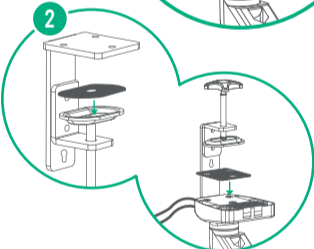

Adhere the bracket cover and the bracket clamp cover to the support block of the bracket clamp.



Tighten the securing bracket by turning the adjuster clockwise and make sure it's tight. If your desk is too thick, adjust the clamp down a notch and re-tighten.



Be careful not to overtighten the clamp or you might cause surface damage to your desk or table

3 Attach to your desk (mounting to desk cable opening)

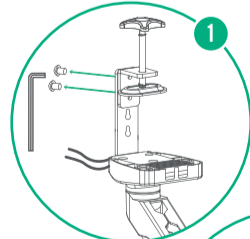

Loosen the two screws that connect the two parts of the clamp.

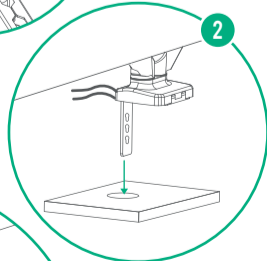

Put the arm through the hole in your table.

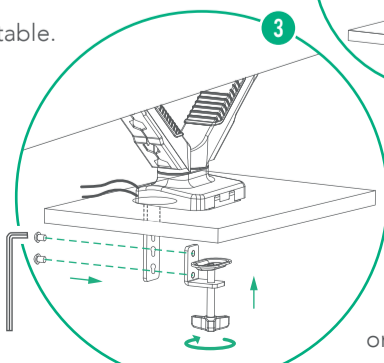

Install the lower part of the clamp with the two screws. Tighten the clamp until it is securely fastened to the desk.

Nearly done!
Just a bit more on the other side of this page...

4 Mount your monitors



This bracket can handle monitors that weigh 6.5kg or less!

1 Install the upper two screws but don't screw them completely just yet. Hang the monitor on the mounting plate.

2 Install the lower two screws. Now you can fasten the upper two screws all the way.

! If your monitor is 75 x 75mm mounting pattern, use the inner 4 holes on the monitor mounts.

! We have included two sizes of screws and spacers to suit most monitors. Select the appropriate screw length to best suit your installation. If you need to use the spacers, place them between your monitor and the mounting plate.

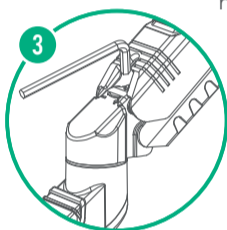
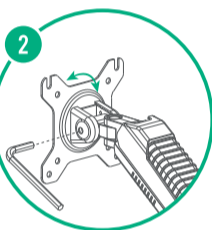
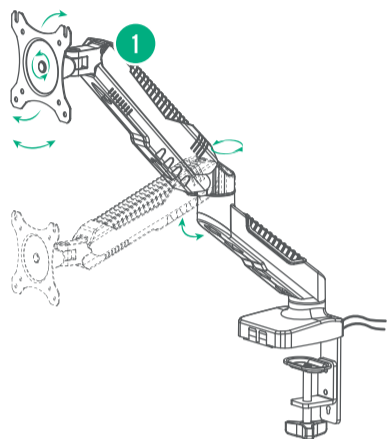
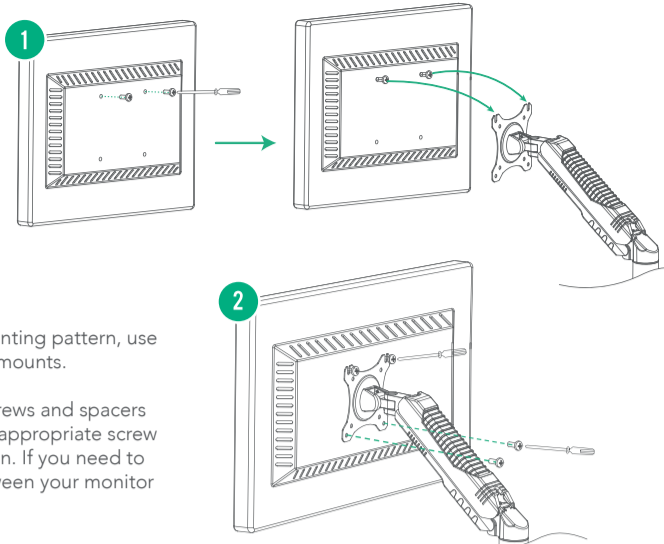

5 Adjust to your space

It's important to make your workspace as ergonomic as possible.

This bracket allows you to adjust the height, tilt and swivel of your monitor's position, so that it's truly fitted to your space and sitting.

To lock in your adjusted position, you will need to tighten the bolt on the mounting plate using the supplied 5mm hex key.

Use the 5mm hex key to adjust the height tension of the gas spring arm. This keeps monitors stable at any position. The heavier the monitor, the further you'll need to turn to the + symbol.



At the back of the bracket, connect the USB cables to your computer. This allows for the bracket to act as an adaptor for plugging in your USB devices!

6 Hide those cables

You can tuck away those unsightly cables into the bracket arm itself.

Tuck the cables into the underside of the lower bracket arm.

Run the cables along the arm until they reach the compartment on the upper part of the arm.

Secure the cables by locking the compartment cover onto the arm.

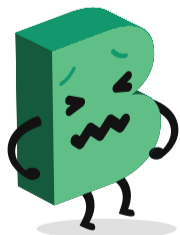
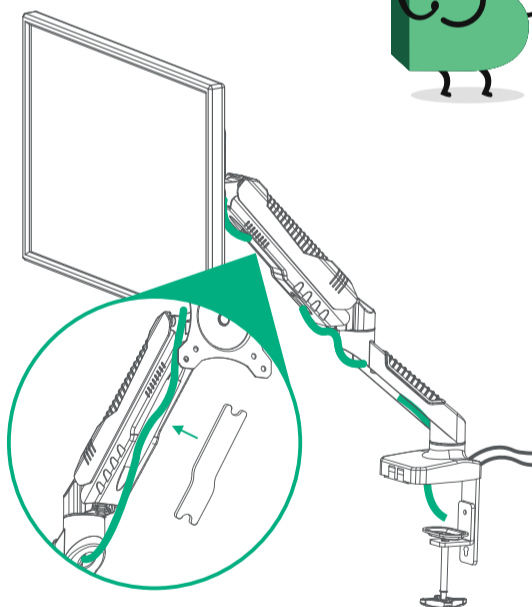

Give us a call

What? You mean this Installation Guide didn't have ALL the answers? Speak to us! We'd love to help you get up and running as quickly as possible. Call our **After Sales Support** on **1300 002 534**.

Operating hours: Monday-Friday, 8:30am-6pm; Saturday, 9am-6pm AEST

Your new Monitor Bracket is ready to enjoy!

Well done, you made it. Now sit back and relax... your new monitor bracket is automatically covered by a 1-year warranty. How nice!

