

**BAUHN**<sup>®</sup>

**58"**

**4K**

Ultra HD  
Smart TV



powered by **webOS** TV

MODEL: ATV58UHDW-0322



# User Manual

**AFTER SALES SUPPORT**

  1300 002 534



 [tempo.org/support](https://tempo.org/support)

MODEL: ATV58UHDW-0322 PRODUCT CODE: 708412 03/2022

# Welcome

Congratulations on your purchase!

This manual tells you all you need to know about using your new BAUHN® product.

Please take special note of any important safety and usage information presented with the  symbol.

All products brought to you by BAUHN® are manufactured to the highest standards of performance and safety and, as part of our philosophy of customer service and satisfaction, are backed by our comprehensive 1 Year Warranty.

Domestic use only: This product is intended for indoor domestic use only. It is not suitable for commercial, industrial or outdoor use. Do not use this product for anything other than its intended purpose, and only use it as described in this manual.

We hope you will enjoy using your purchase for many years to come.

# Contents

Welcome	2	Advanced Controls (TV Setting Menus)	19	USB Mode	43
Unpack and Prepare	4	Picture	21	Set Up	43
What's in the Box	4	Sound	24	Viewing Photos and Videos	44
 Important Tips	5	Programmes	26	Photo Player	44
Attaching the Stand	6	Connection	28	Video Player	45
Wall-Mounting the TV	7	General	30	Playing Music	46
Connect to Power	8	Accessibility	34	Music Player	46
Connect your Antenna	8	Support	35	Troubleshooting	47
Controls and Connections	9	High Dynamic Range (HDR)	36	Specifications	50
Get to Know your TV	9	Smart TV	37	Compliance and Responsible Disposal	51
Buttons on the TV	9	Web Browser	38	Warranty Information	52
Ports on the TV	10	TV Guide	39	Repair and Refurbished Goods or Parts Notice	53
Remote Control	12	Recording	40		
Setup	12	Using Instant Recording	41		
Using the Remote Control	13	Using the TV Scheduler	41		
Remote Pairing	13	Programme Scheduling	42		
Magic Remote	14	Manual Scheduling	42		
Pairing the Remote	16	Using Live Playback (Real-time Playback)	42		
On-Screen Set Up	17				
LG ThinQ App	18				

# Unpack and Prepare

## What's in the Box

Before installing your new TV, check you have everything needed.

In the box you will find:

- A. 58" 4K Ultra HD Smart TV
- B. Magic Remote
- C. AA Activ Energy Batteries (2)
- D. TV Stands (2)
- E. Screws for TV Stands (4)
- F. Warning Sheet
- G. TV Toppling Safety Message
- H. Quick Start Guide
- I. Warranty Certificate
- J. General Safety Warnings
- K. User Manual

You will need:

- Phillips-head screwdriver (for stand installation)
- Antenna cable (to watch live TV)
- Someone to help you lift and install your TV
- Broadband internet connection (to use smart apps)



See the flap of the box for how to handle the TV without damaging it!



## Important Tips

- Place the TV on a level surface.
- Place the TV away from any source that may generate heat or vibrations.
- Make sure there is enough space around vents for airflow.
- The remote control works up to 5 metres away from the TV.
- Unplug the TV before cleaning it.
- Clean using a dry cloth only - do not use water or chemicals.
- Use only the power supply provided.
- It is highly recommended to use safety straps for securing the TV in place.
- Keep liquid, children and pets away from the TV at all times.

## Attaching the Stand

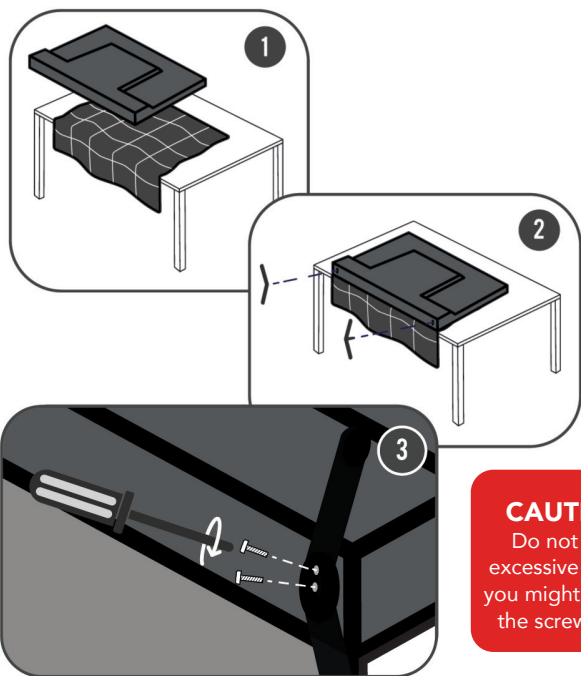

**CAUTION!**  
Do not apply excessive force as you might damage the screw holes.



- This TV is heavy! We recommend asking someone to help you lift it.
- Unplug the TV from the power outlet before installing or removing the stand.
- **DO NOT** place the TV standing upright without its stand attached; it could damage the remote sensor at the bottom of the TV.
- Only touch the frame, not the screen.
- It is highly recommended to use safety straps for securing the TV.

Unless you are wall-mounting the TV, you will need to attach its stand/legs.

1. Lay the TV face-down on a soft, flat surface (like the sofa, or a towel on a table) larger than the TV itself.
2. Match the stands to the installation points on the underside of the TV.
3. Attach the stands to the TV at the installation points using the screws provided. (Grab a screwdriver for this bit).

# Wall-Mounting the TV



- Unplug the TV from the power outlet before wall-mounting.
- Contact a professional for assistance with wall-mounting the TV.

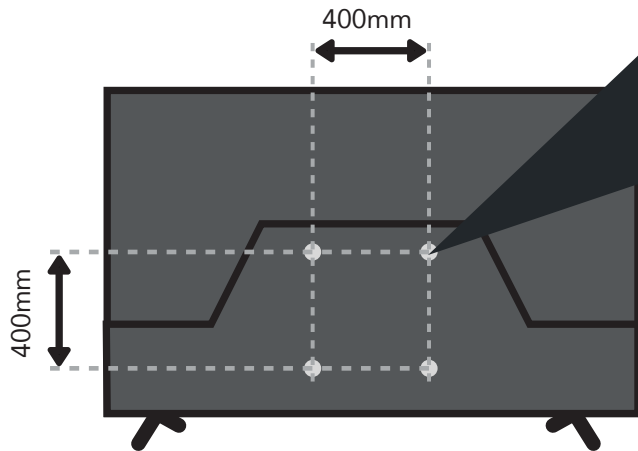

Back of the TV

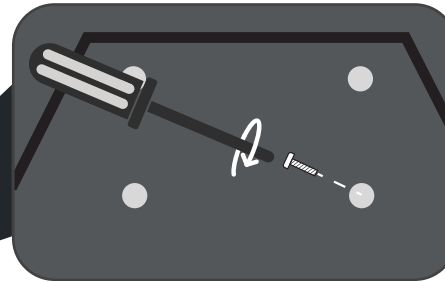

## Required

- VESA Mounting Bracket
- 4 x M6\*10mm screws (or longer as required)

The TV comes with holes on the back panel for use with wall-mounting brackets (bracket not included).

Use four standard M6\*10mm screws (or longer, depending on the mounting bracket) to wall-mount this TV (screws are not included).



The screws in the package are for securing the TV stand only. If you are wall-mounting the TV, consult a qualified installer for advice on bracket support and wall support.

## Connect to Power

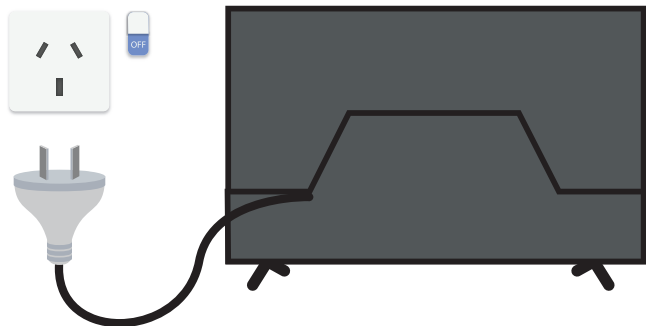

## Connect your Antenna

### Free-to-air TV in HD (High Definition)

Example  
HD Channels

ABC HD  
SBS ONE HD  
7HD  
9HD  
10 HD  
PRIME7 HD  
WIN HD

High Definition (HD) channels provide the best viewing quality and are available with a digital antenna connection.

TV channels in Ultra HD resolution are not currently available in Australia. Therefore when you watch HD broadcast signals on an Ultra HD TV, the picture can appear 'soft' and lacks the detail you see when watching the same content on an HD TV.

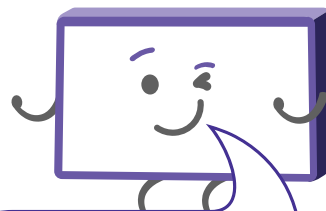

Don't forget to plug in the TV to the power outlet. Leave the power switched off until installation is finished.



Make sure the TV is **switched off** at the power outlet until you have finished connecting your cables.

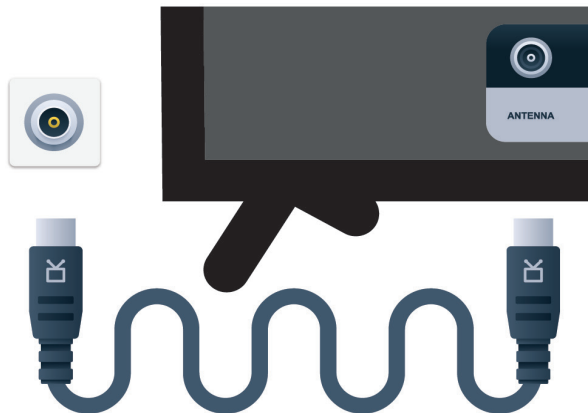

Antenna cable not included.



# Controls and Connections

## Get to Know your TV





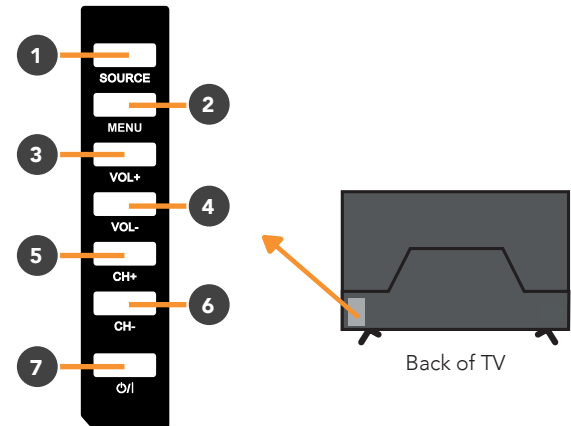

## Buttons on the TV

1. SOURCE: Change the input source.
2. MENU: Enter the settings menu.
3. VOL +: Increase volume level.
4. VOL -: Decrease volume level.
5. CH+: Select the next channel.
6. CH-: Select the previous channel.
7.  $\odot/|$ : Switch the TV on or to standby.

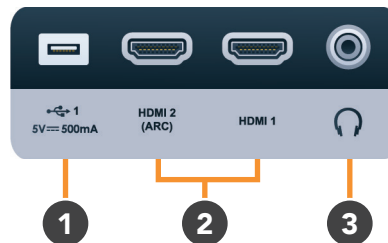
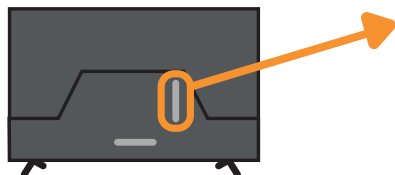







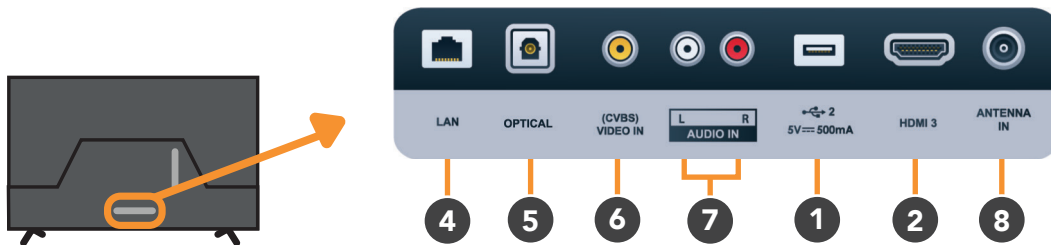



# Ports on the TV



1	<p>USB</p> 	STORAGE	<p>Plug in a USB stick/drive to PVR record and pause live TV. Play media files stored on your USB storage device (supported file codecs and extensions may vary). Update the TV software via USB. Note: Time-shift function requires a USB-HDD for storage.</p>
2	<p>HDMI</p> <p>Use a high-speed HDMI cable for best picture and sound quality.</p> 	<p>SOUND</p> <p>PICTURE</p> <p>COMPUTER</p>	<p>All-digital connection between the TV and any HDMI device. Supports Ultra HD. Requires a HDMI cable (not included).</p>
3	<p>Headphone Jack</p> 	SOUND	<p>Connect to your headphones, amplifier or audio device, using an AUX cable (not included).</p>



4	LAN	 	INTERNET	Connect to your broadband modem using an Ethernet cable (not included).
5	OPTICAL	 	SOUND	Connect an external digital audio device. Use an Optical cable (not included) to connect the unit with an amplifier, soundbar or other audio decoding device for digital audio signal output.
6	(CVBS) VIDEO IN	 	PICTURE	You can use this to connect your DVD player. Supports Standard Definition (SD) picture quality. Requires an AV cable (not included).
7	AUDIO IN	 	SOUND	You can use this to connect Audio to your TV for AV or Component video inputs. Requires an AV cable (not included).
8	ANTENNA IN	 	FREE TO-AIR TV	Connect your antenna for live TV. (Antenna cable not included).

# Remote Control

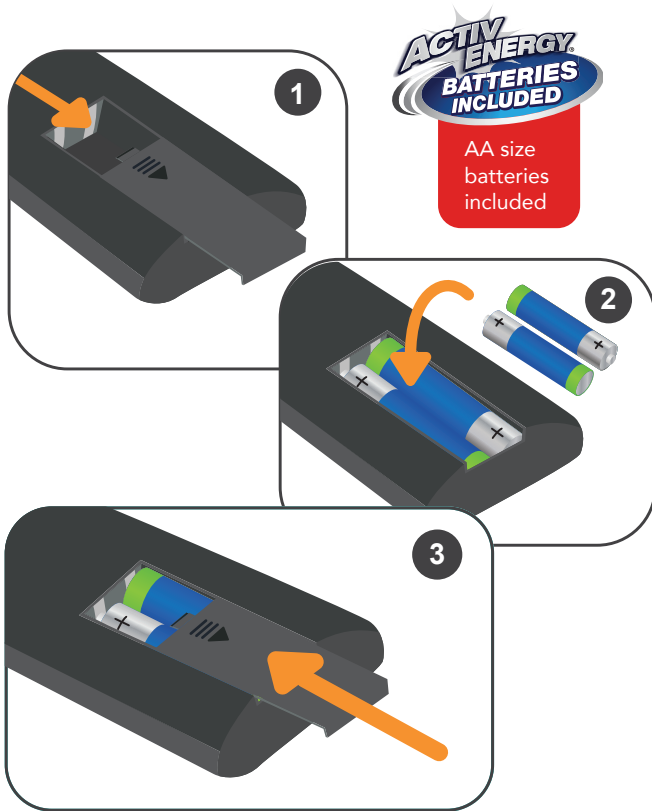

## Setup

Insert two AA size batteries according to the polarity markings (+/-) inside the compartment. Make sure the batteries are correctly aligned and properly pushed into place.



### Precautions When Using Batteries

- Do not use old and new batteries together.
- Do not use different types of batteries (e.g. Manganese and Alkaline batteries) together.
- Remove the batteries from the remote if you do not intend to use it for a long time.
- When discarding used batteries, follow any guidelines for recycling and disposal of batteries that apply in your local area.
- Keep batteries away from children and pets.
- Never throw batteries into a fire or expose them to extreme heat.

## Using the Remote Control

To use the remote, point it towards the remote sensor at the front of the TV. The remote will not operate if its path is blocked.

The remote has a range of up to about 5 metres from the TV at an angle of up to 30 degrees to either side of the sensor, as illustrated below.

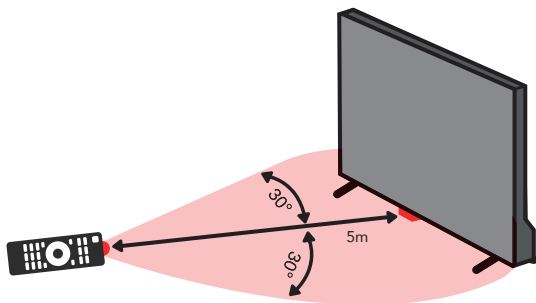

Image is an example only. Remote sensor location on TV may vary.



### Remote Hints and Tips

- Do not drop, step on or otherwise impact the remote control. This may damage the parts or lead to malfunction.
- Do not place objects between the remote control and the remote sensor.
- Do not use this remote control while simultaneously operating a remote control for other devices.

## Remote Pairing

This remote control uses both Bluetooth® and IR (infrared) to send its commands to the TV.

- You can use this remote control via IR for most operations.
- To use advanced operations like voice search, you need to pair the TV with the remote control. See page 16 for more information on pairing your remote.

# Magic Remote

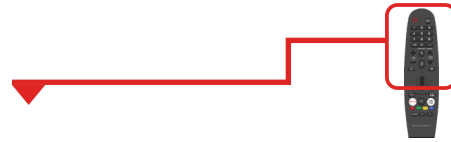

 : Switch the TV to On or Standby

Microphone

**NUMBER BUTTONS:** Key in a TV channel number

 : Display channel list

**0/QUICK ACCESS:** Press and hold to view quick access edit screen

 : Mute/unmute the sound

 : Turn the volume up/down

 : Go to the HOME page (Smart TV)

 : Switch the main set top box to On or Standby

**••• AD / SAP :** Press to display additional buttons/settings. Press and hold for audio description

 : Change to the next/previous channel

 : Press and hold to speak when using the voice recognition function

 : Press to enter the quick settings menu. Press and hold to enter the main settings menu



▲ / ▼ / ◀ / ▶: Press the **UP/DOWN/LEFT/RIGHT** buttons to navigate

**SCROLL WHEEL/OK BUTTON:**  
Scroll up/down and press to confirm selection

↶: Return to previous. Press and hold to exit

**NETFLIX**: Launch the Netflix app

● / ●● / ●●● / ●●●● **RED/GREEN/YELLOW/BLUE**: Functions are according to the on-screen display

**MOVIES**: Search for movies



≡ / **GUIDE**: Launch TV Guide

📺 (**SOURCE**): Select the input source and enter the HOME dashboard

prime video: Launch the Amazon Prime Video app

▶: Play selection

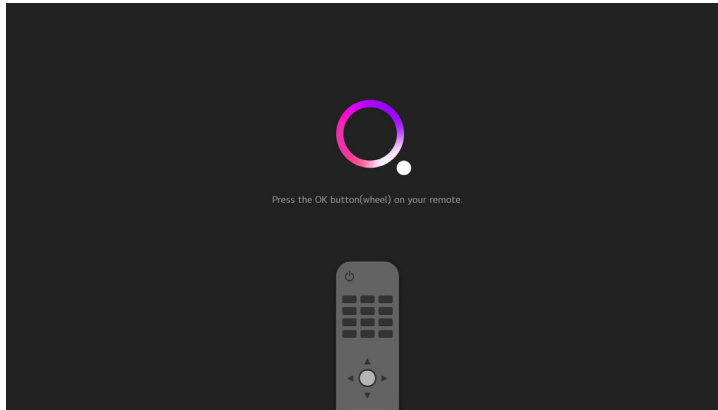

⏸: Pause selection

## Pairing the Remote



During the first time setup process, when the screen shown above appears, point the remote control towards the IR sensor of the TV and press the **SCROLL WHEEL/OK** button to pair the remote.

If pairing is unsuccessful, turn the TV off and turn back on and pair again.

To unpair the remote, when the TV is on, press and hold the  and  buttons for 5 seconds (until the remote's LED is blinking), and the remote will automatically unpair with the TV.



# On-Screen Set Up



Make sure equipment is properly connected (as shown on pages 10-11) before connecting the TV to power.

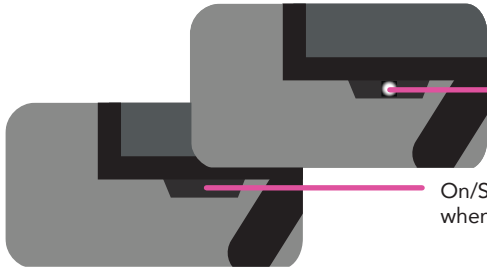

On/Standby light is WHITE in standby mode.

On/Standby light is OFF when the TV is on.

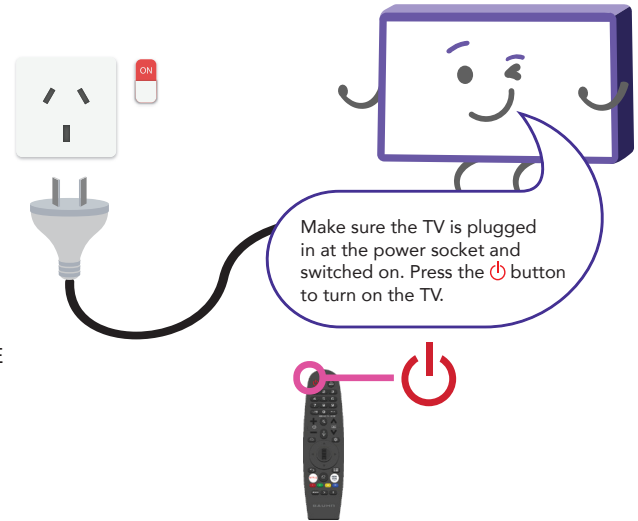

## First Time Setup menu

When you turn the TV on for the first time, the First Time Setup menu will appear.

Follow the prompts using the ▲ / ▼ / ◀ / ▶ / **SCROLL WHEEL** / **OK** buttons to select your preferences. You will be guided through:

1. Language & Location
2. Connect to the Internet
3. Terms & Conditions
4. User Environment
5. Settings & Address
6. The Way to Watch TV (Select TV Only)
7. Program Tuning
8. Connect to the ThinQ App

If you make an error, you can update your preferences in the settings menu later.

## 2. Connect to the Internet

If you are using a wired network, connect an ethernet cable to the TV. The TV will automatically connect to the Internet.

If you are using a wireless connection, select 'Wi-Fi Network'. The TV will scan for nearby wireless networks. Make sure that the TV is within the range of your wireless modem/router, and you have your Wi-Fi password handy. Select your network, enter network password using the on-screen keyboard and select ENTER. Press OK to connect.

Or, you can connect to the internet later by going to the User Menu settings.

# LG ThinQ App

You can use the LG ThinQ app to control key TV functions instead of the remote control.

Note: you need an Android device running Android 4.3 or higher to use the app.

1. On your smart phone, search and download the LG ThinQ app from the Play Store/App store (alternatively, scan the QR code below):



For Android



For iOS



2. After app has downloaded and installed, open up the app. Ensure that both your smart phone and TV are using the same Wi-Fi network.
3. Select TV and it will automatically search for nearby TV.
4. A PIN will appear on your TV screen, enter the PIN on your smart phone tap "Done."
5. Select "LINK" on your smart phone to complete registration.

You can now use the app to control key TV functions.

# Advanced Controls (TV Setting Menus)

## Menu Navigation Buttons

Press the  then **SCROLL WHEEL/OK BUTTON** to display the TV settings menu. See the guide below for all the other buttons you'll need to use to adjust and change your settings.

Function	Remote Button
Display the quick menu	
Display the main menu	 then <b>SCROLL WHEEL/OK BUTTON</b>
Enter a sub menu	<b>SCROLL WHEEL/OK BUTTON</b>
Adjust a value	▲ / ▼ / ◀ / ▶
Return to the previous menu	↶
Exit a menu	Hold ↶

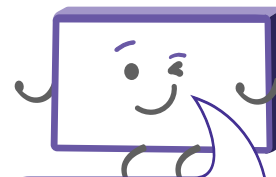

Once you have programmed any settings, the unit will retain them in its memory until you change them, even after turning the TV off.







## Menu Index



Picture

21

- Picture Mode:
  - Backlight, Contrast, Brightness, Sharpness, Colour, Tint, Colour Temperature, Advanced Controls, Picture Options, Apply To All Inputs, Reset
- Aspect Ratio Settings
- Energy Saving
- Additional Settings:
  - Eye Comfort Mode, HDMI Ultra HD Deep Colour, Instant Game Response

 <u>Sound</u> <span style="float: right;">24</span>	 <u>Connection</u> <span style="float: right;">28</span>	 <u>Accessibility</u> <span style="float: right;">34</span>
<ul style="list-style-type: none"> <li>• Sound Mode: <ul style="list-style-type: none"> <li>• Balance, Ultra Surround, Equalizer, Reset</li> </ul> </li> <li>• Sound Out</li> <li>• Additional Settings: <ul style="list-style-type: none"> <li>• TV Installation Type, Volume Mode, DTV Audio Setting, AV Sync Adjustment, HDMI Input Audio Format, LG Sound Sync, Digital Sound Out</li> </ul> </li> </ul>	<ul style="list-style-type: none"> <li>• TV Name</li> <li>• Network Connection Settings: <ul style="list-style-type: none"> <li>• Wired Connection (Ethernet), Wi-Fi Connection</li> </ul> </li> <li>• Device Connection Settings</li> <li>• Mobile Connection Management</li> </ul>	<ul style="list-style-type: none"> <li>• Audio Description</li> <li>• Audio Description Volume</li> <li>• High Contrast</li> <li>• Grayscale</li> <li>• Invert Colours</li> <li>• Hard of Hearing</li> <li>• Subtitles</li> </ul>
 <u>Programmes</u> <span style="float: right;">26</span>	 <u>General</u> <span style="float: right;">30</span>	 <u>Support</u> <span style="float: right;">35</span>
<ul style="list-style-type: none"> <li>• Programme Tuning</li> <li>• Programme Manager</li> <li>• Subtitle Language</li> <li>• Audio Language</li> <li>• Dual Mono</li> <li>• HbbTV</li> </ul>	<ul style="list-style-type: none"> <li>• AI Service&gt;AI Recommendation</li> <li>• Language</li> <li>• Location</li> <li>• Time</li> <li>• Safety</li> <li>• Account Management</li> <li>• Home Settings</li> <li>• Additional Settings: <ul style="list-style-type: none"> <li>• Settings Help, Menu Transparency, Screen Saver, No Signal Image, Eco Mode, Quick Start+, Standby Light</li> </ul> </li> </ul>	<ul style="list-style-type: none"> <li>• Software Update</li> <li>• TV Information</li> <li>• Notifications</li> <li>• Additional Settings: <ul style="list-style-type: none"> <li>• User Agreements, Legal Notice, Open Source Software Notice, Set ID</li> <li>• Reset to Initial Settings</li> </ul> </li> </ul>
		 <u>High Dynamic Range (HDR)</u> <span style="float: right;">36</span>

# Picture



To access picture settings, navigate from  > **SCROLL WHEEL/OK BUTTON** > Picture

## Picture Mode

**Vivid** : Enhanced brightness with lower contrast, colour depth and edges for standing out in very bright places such as storefronts.

**APS** (Auto Power Save) : Settings are optimised to reduce power consumption.

**Cinema** : Settings are optimised for watching movies.

**Cricket** : Settings are optimised for watching sports.

## Picture Mode settings

Option	Description
Backlight	Adjust the screen brightness by adjusting the backlight. The closer to 100, the brighter the screen.
Contrast	Adjust the contrast of the bright and dark areas of the picture. The closer to 100, the higher the contrast.
Brightness	Adjust the overall screen brightness. The closer to 100, the brighter the picture.
Sharpness	Adjust the sharpness of the picture. The closer to 50, the sharper and clearer the image.
Colour	Adjust the saturation. The closer to 100, the deeper the colour.

Option	Description
Tint	Adjust the colour balance between red and green. The closer red is to 50, colour will be more 'red' dominant. The closer green is to 50, colour will be more 'green' dominant.
Colour Temperature	Adjust the on-screen colour temperature.
Advanced Controls	See table below for more information.
Picture Options	<ul style="list-style-type: none"> <li>• Noise Reduction</li> <li>• Black Level Auto</li> <li>• Real Cinema</li> <li>• TruMotion</li> </ul>
Apply To All Inputs	Select to apply current picture settings to all input modes.
Reset	Reset picture mode settings to factory default.

## Advanced Controls

Option	Description
Dynamic Contrast	Adjust the shadow balance for optimal results.

Option	Description
Dynamic Colour	Adjust the colour and saturation of the picture to make the image more colourful and lively.
Gamma	Adjust mid level brightness of picture.

## Aspect Ratio Settings

- Aspect Ratio: this item is used to adjust the video size. Sizes may differ between input sources.
- Just Scan: turn just scan to auto/on/off.

## Energy Saving

Adjust screen brightness to reduce power consumption (options:off/minimum/medium/maximum/screen off).

## Additional Settings

Option	Description
Eye Comfort Mode	Adjust colour temperature to reduce eye fatigue.
HDMI Ultra HD Deep Colour	Connect a playback device and turn HDMI Ultra HD Deep Colour on. (Device must support HDMI ULTRA HD Deep Colour).
Instant Game Response	When a gaming device is connected to the HDMI port, turn Instant Gaming Response on to optimize gaming experience. (Some devices may not support this function).

# Sound

To access sound settings, navigate from  > **SCROLL WHEEL/OK BUTTON** > Sound

Option	Description
Sound Mode	<b>Standard (User)</b> <b>Cinema</b> <b>Clear Voice III</b> <b>Cricket</b> <b>Music</b> <b>Game</b>
Balance	Adjust the audio output between the left and right speakers.
Ultra Surround	Adjust surround sound effect from your TV speakers.
Equalizer	Adjust selected frequencies. These options are available when sound mode is set to user.
Reset	Reset sound settings to factory default.

## Sound Out

Select sound output.

Option	Description
Internal TV Speaker	Sound is played through the TV's speakers.
Bluetooth	Connect to a Bluetooth audio device and sound will be played from the connected device.
Mobile Device	Sound is played through the mobile device using the LG ThinQ app.
Optical	Connect an optical supported audio device to the DIGITAL AUDIO OUT (OPTICAL) port on the TV.
HDMI ARC	Connect to an external audio device via the HDMI (ARC) port on the TV.



## Wired Headphones

Connect to your wired headphones to enjoy sound only you can hear.

## Optical + Internal TV Speaker

Sound is played through the TV's speakers and connected external audio device simultaneously.

## Wired Headphones + Internal TV Speaker

Sound is played through the TV's speakers and connected headphones simultaneously.

## Additional Settings

### Option

### Description

## TV Installation Type

Optimizes sound based on whether TV is wall mounted or on stands.

## Volume Mode

Auto volume: turn on and each programme's volume will be adjusted automatically to the same level.

Volume increase amount: select Low/Medium/High to adjust volume range.

## DTV Audio Setting

Select DTV audio. Options: MPEG, Dolby Digital, Dolby Digital Plus, HE-AAC, Auto.

## AV Sync Adjustment

Outputs the broadcast signals or the sound from external devices without audio delay. When "Bypass" is set to off, it will adjust synchronisation of sound from the TV or external speaker.

## HDMI Input Audio Format

Set audio for each HDMI input. Options: Bitstream, PCM.

## LG Sound Sync

Connect the LG Sound Sync device to the optical port and set sound out to optical. With this feature on, you can adjust the volume of the connected LG Sound Sync device using the remote.

## Digital Sound Out

Set digital sound output mode. Options: Auto, PCM.



# Programmes



To access programme settings, navigate from  > **SCROLL WHEEL/OK BUTTON** > Programmes

## Programme Tuning

Option	Description
Auto Tuning	Automatically scans all available free-to-air TV channels. Adjust settings (default settings are set for Australia), select 'Search' and press OK.
Manual Tuning	Manually select and scan digital TV channels.
Programme Mode	Select channel type.
Signal Test	Display current signal information (DTV mode only).

## Programme Manager

Edit all programmes

Option	Description
Lock/Unlock	Lock/Unlock the selected programmes.
Skip/Restore	Set the selected programmes to be skipped when switching programmes or disable the skipping option.
Move	Move selected programmes.
Edit Programme Numbers	Change number of selected programmes.

## Edit favourite programmes

Option	Description
Move	Select one or more programmes in the Preferred Programmes list and select the position to move it to.
Change Group Name	Change the name of the favourite programmes list.
Sort by Programme	Sort out the favourite programmes list by programme/genre.

## Subtitle Language

Select preferred subtitle language.

## Audio Language

Select preferred audio language.

## Dual Mono

Switch the soundtrack when programme has dual soundtrack available.

## HbbTV

Turn Hybrid Broadcast Broadband TV (HbbTV) On/Off.



# Connection

To access connection settings, navigate from  > **SCROLL WHEEL/OK BUTTON** > Connection

## TV Name

Show current TV name. You can also use the screen keyboard to set to your preferred name (up to 25 characters can be entered).

## Network Connection Settings

See below.

### Wired Connection (Ethernet)

If the router connected to the network supports DHCP feature, the TV will automatically connect to the network. If it does not automatically connect, select Edit to manually setup the connection.

### Wi-Fi Connection

If you have set up the TV for a wireless network, you can check and connect to the available wireless Internet networks.

Option	Description
Add a Hidden Wireless Network	Directly enter a network's name to add the network.
Connect via PBC	Connect through Wi-Fi Protected Setup-Push Button Configuration.
Connect via PIN	Connected to an access point using Wi-Fi Protected Setup PIN.
Advanced Wi-Fi Settings	View connection information such as IP address and so on.

## Device Connection Settings

Option	Description
Auto Device Connection	Automatically allows you to control the devices connected via HDMI with the remote control.
SIMPLINK (HDMI CEC)	Manage devices (i.e. set top box or soundbar) connected to a TV via HDMI with the remote control. Up to three devices can be connected and simultaneously used.
Auto Power Sync	When turned On, powering a SIMPLINK connected device will also turn the TV on. Turning the TV off will also power off the connected device.
LG Wireless Keyboard	Connect a LG wireless keyboard to your TV.
Universal Control Settings	Use the TV's remote control to operate other peripheral devices connected to the TV.

## Mobile Connection Management

Use a smart device connected to the TV to control the TV.

Option	Description
TV on with mobile	You can turn your TV on with your smart device. Both the TV and device must be connected to the same network and smart device must support 'TV on with mobile'.
Screen Share	Delete connection history of device connected to the TV via Screen Share.
Sound Share	Delete connection history of device connected to the TV via Bluetooth.

# General

To access general settings, navigate from  > **SCROLL WHEEL/OK BUTTON** > General

## AI Service > AI Recommendation

Option	Description
Voice recognition help and settings	Change settings related to speech recognition features, such as turning Voice Response on/off.
Content Recommendations	Receive content recommendations based on TV content viewing pattern.
Delete Usage Data	Reset content and app usage history by deleting user data.

## Language

Option	Description
Menu Language	Select on screen display language.
Primary Audio Language	Select primary audio language. Default will be used for programmes that do not support multiple languages.
Secondary Audio Language	Select secondary audio language. Default will be used for programmes that do not support multiple languages.
Keyboard Language	Select on screen keyboard language.
Primary Teletext Language	Select primary teletext language.
Secondary Teletext Language	Select secondary teletext language.

## Location

Option	Description
Broadcast Country	Select the TV's broadcast country.
Service Area Postcode	Enter your postcode to set the TV's broadcast location.
Services Country	Set country manually. Note: setting the country manually must be done when not connected to a network.

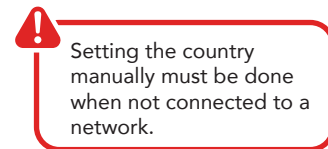

## Time

Option	Description
Set Automatically	Use network provided time.
Time Zone	Adjust the time zone.
Timers	<ul style="list-style-type: none"><li>• Sleep Timer: select the desired Auto Sleep (Standby) duration.</li><li>• Power On Timer: set the power on timer.</li><li>• Power Off Timer: set the power off timer.</li><li>• 4 Hours Auto Power Off: when turned on, the TV will turn off if no buttons are pressed for 4 hours.</li></ul>









## Safety

Option	Description
General Switch	Turn on to enable lock function.
TV Rating Locks	Restrict watching programmes based on rating.
Programme Locks	Select the programmes to lock.
Application Locks	Select the applications to lock.
Input Locks	Select the inputs to lock.



Factory Password: 0000

Master Password: 0313

- Reset TV password. Factory password is "0000". To reset your password:
- Press the  button on the remote control.
- Reset Password
- Select the ALL SETTINGS icon, then General > Safety
  - Press  ,  ,   and   on the remote control, and the master password window will appear.
  - Enter "0313" and press Enter. The password is now reset.

## Account Management

Use your email address to create a new LG account.



## Home Settings

Option	Description
Home Auto Launch	Set Home to launch automatically when TV is turned on.

## Additional Settings

Option	Description
Settings Help	Turn settings help on/off. (Turning on will show description text of each setting).
Menu Transparency	Turn on to make some menus (Live Menu, Search etc.) transparent.
Screen Saver	Turn screen saver on and when screen has had no activity for an hour, the display screen will show a screen saver.
No Signal Image	Turn on and a default image will be displayed on screen if no signal. Turn off and "no signal" will be displayed on screen if no signal.
Eco Mode	Set power options to reduce energy consumption. Options: On, Off
Quick Start+	Turn on and the TV will be in standby mode when turned off allowing for a quicker start when next turned on.
Standby Light	Turn TV standby light on/off.



# Accessibility

To access accessibility settings, navigate from  > **SCROLL WHEEL/OK BUTTON** > Accessibility

Option	Description
Audio Description	Guide menus and operations with voice for visually impaired viewers.
Audio Description Volume	Audio Description (AD) provides an additional audio track for visually challenged persons (DTV only, subject to program).
High Contrast	Turn high contrast on/off.
Grayscale	Change menu screen to black and white colour.
Invert Colours	Invert and calibrate colours in menu to enhance visibility.
Hard of Hearing	Display captions for hearing-impaired viewers to use the TV. Note: only works when the programme supports subtitles.
Subtitles	Turn subtitles on/off.

# Support

To access support settings, navigate from  > **SCROLL WHEEL/OK BUTTON** > Support

Option	Description
Software Update	Check for system software updates and update if desired.
TV Information	View device name, serial number, software version and available storage.
Notifications	Check notifications about user settings or TV status.
Additional Settings	See table below.
Reset to Initial Settings	Reset to factory default settings.

## Additional Settings

Option	Description
User Agreements	Read and accept/decline the User Agreements.
Legal Notice	Read up on legal notices and opt out of personalised ads.
Open Source Software Notice	View TV software information.
Set ID	Set the TV device ID (1-99).



# High Dynamic Range (HDR)

## About the HDR feature

High Dynamic Range (HDR) is a picture feature on your TV that attempts to mimic the way visuals are perceived in real life by the human eye.

By using this feature, the TV can reproduce greater dynamic range of luminosity by capturing and then combining several different exposures.

HDR promises better picture quality thanks to brighter, more realistic highlights, more realistic colour and other improvements.

It delivers the look that the filmmakers intended to achieve, showing the hidden areas of dark shadows and sunlight with full clarity, colour and detail.

## HDR on your TV

HDR is supported in HDMI and USB input sources and by Netflix app.

# Smart TV

Before you start using apps, your TV must be connected to the internet.

The speed of your internet connection determines the quality of your audio/video experience when you watch streaming content.

Accessing internet content may count towards your download limit and may incur fees from third parties such as your internet service provider (ISP).



## Services Country

If you don't set the country automatically, you can set manually. You must set the country manually when not connected to a network. The TV will recommend and display the applications for the selected country.

## NETFLIX

Netflix is a streaming service that offers unlimited viewing of a wide variety of award-winning TV shows, movies and documentaries.

A paid subscription is required.

This TV can play Netflix content in 4K Ultra HD HDR resolution, however the playback resolution may be lower depending on your subscription level and your network speed.

Streaming Netflix content will count towards the data usage of your broadband plan.

Function

Remote Button

Display the Home/App screen



Select different Apps



Open your desired App

**SCROLL WHEEL/ OK  
BUTTON**



# Web Browser

Using the web browser, you can surf the Internet on the TV similar to how you would do on a PC.  
NOTE: Use a wired or wireless keyboard and mouse (not provided) for an easier web browsing experience.

From the Home page, select a recommended or bookmarked site and press the **SCROLL WHEEL/ OK BUTTON** to visit the site.

You can enter the web address using the on-screen keyboard, remote keyboard or connected wireless keyboard.

Select the 'Settings' icon to access the browser menu settings.

Select the "Add to bookmark" icon and press the **SCROLL WHEEL/OK BUTTON** to add the web address as a favourite.

Press **↶** to exit the web browser.

## On-screen keyboard

Use **▲/▼/◀/▶** buttons and press the **SCROLL WHEEL/ OK BUTTON** button to enter the character.

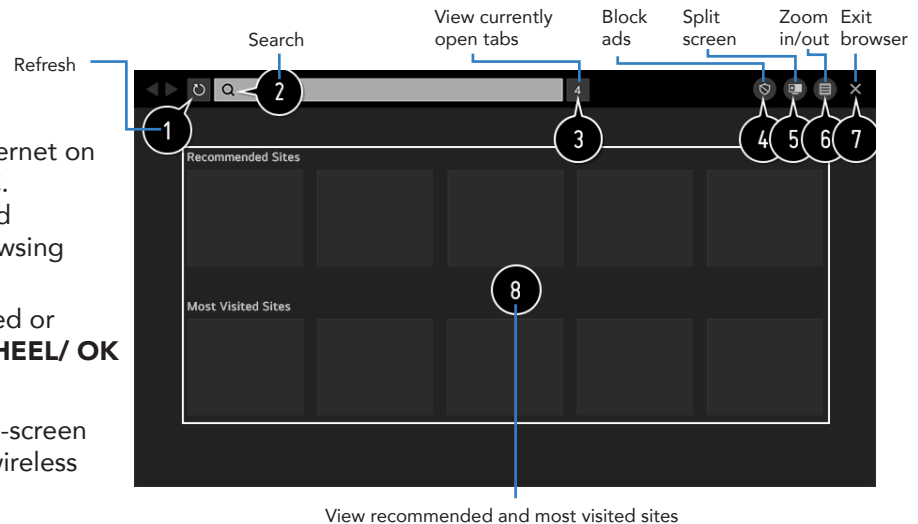

# TV Guide

## TV Guide Functions

Function	Remote Button
Switch between TV Guide/ Schedule List, Channel List and Program List	◀/▶
Browse Channel List and Program List	▲ / ▼
View program information, schedule for recording or reminder	<b>SCROLL WHEEL/ OK BUTTON</b>
Exit TV Guide menu	↶

### (Free to air TV)

To access the TV guide, press the **≡ /GUIDE** button on the remote.

To activate the TV Channels use the **▲ / ▼** buttons to select a channel in the left column, then press the **SCROLL WHEEL/OK BUTTON** to confirm.



# Recording

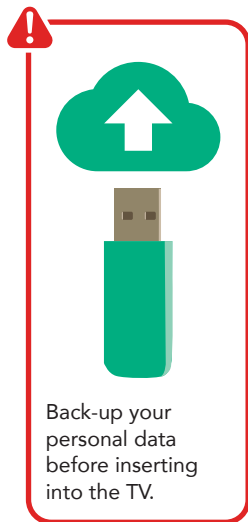

## Important Tips:



- Back-up your personal data before plugging in your USB to the TV. We do not assume liability for any loss of data due to misuse or malfunction.
- You cannot change channels while in recording mode.
- If the signal is interrupted while in recording mode, the recording will stop until the signal is established.
- Do not turn the TV off while it is in time-shift mode.
- The file recorded can only be used on this TV. Do not copy it to any other device.
- When connecting or disconnecting the USB storage device, ensure the TV is not in USB mode, otherwise the USB device or the files stored on it may be damaged.









**Time-shift function requires a USB-HDD for storage.**



# Using Instant Recording

- Connect a USB HDD or USB stick to the USB port on the TV.
- When watching the live programme, press the **SCROLL WHEEL/OK** button.
- Press the  button on the bottom of the screen to start recording.
- Press the  button on the bottom of the screen to stop the recording.

# Using the TV Scheduler

- Press the  button on the remote, and select "TV Scheduler" on the TV screen.
- Select  on the top right of the screen.
-  : Change alignment or apply filter.
-  : Set Delete Mode.
-  : Set new scheduled recording.
-  : Set new reminder.
-  : Launch guide.







## Programme Scheduling

- Press the  button on the remote, and select "Guide" on the TV screen.
- Select the programme and to record the programme live, select the "Record" or "Watch" button on the screen.
- For programmes yet to air, select the "Scheduled Recording" or "reminder" button on the screen.

Note: scheduled recording does not guarantee the exact recording time of the programme.

## Manual Scheduling

- Press the  button on the remote, and select "TV Scheduler" on the TV screen.
- Select  on the top right of the screen.
- Select either  or  and select "Create Manually".
- Set the date, time and programme to record or watch.

Note: scheduled recording must be at least a minute.

## Using Live Playback (Real-time Playback)

- Connect a USB HDD to the USB port on the TV.
- When watching the live programme, press the **SCROLL WHEEL/ OK BUTTON** button.
- Select  on the bottom of the screen to display list of recorded programs.



- You cannot use a USB stick. A USB HDD with 80GB or more of storage is required for the function to work.
- Live playback function does not work for radio programmes.
- Changing programmes during live playback will delete all data of the previous programme.

# USB Mode









## Set up

Insert your USB into a USB port on the TV.

Press the  button to select 'USB' mode.









You can only play Photos in the Photo category, and Music in the Music category. Make sure you select the correct category for the file you wish to play.







Function	Remote Button
Choose a Source or File	 /  /  / 
Choose media categories	 /  / <b>SCROLL WHEEL/OK BUTTON</b>
Start playing your media	<b>SCROLL WHEEL/OK BUTTON</b>
Return to previous screen	
Exit media mode	Press and hold 









# Viewing Photos and Videos

- Press the  button on the remote control to access the HOME page.
- Select  and choose the storage device with the photos and videos to view.
- Select and view your photos and videos.
-  : Select viewing method and type of content.
-  : Delete content.
-  : Play content (you cannot select both photos and videos to play).
-  : Copy to USB storage device.
-  : Search for specific file.

## Photo Player









- Photo player will launch when viewing your photos.
-  : Return to content list.
-  : Play background music through the music player.
-  : Zoom in/out.
-  : Play slide show.
-  : Rotate photo.
-  : View 360° photos (viewing on VR may distort image).
-  : Adjust size/ratio of photo and speed/transition effect of slide show.

# Video Player







- Video player will launch when playing your videos.
-  : Return to content list.
-  : Display playlist.
-  : Control video playback functions.
-  : Rotate video.
-  : View 360° video (viewing on VR may distort video).
-  : Video repeat/shuffle settings.
-  : Additional options (subtitles, set audio tracks, resume from last viewed time).



# Playing Music

- Press the  button on the remote control to access the HOME page.
- Select  and choose the storage device. Select songs and add them to "My Playlist". Play your music.
-  : Select type of content.
-  : Delete song.
-  : Select song and add it to "My Playlist".
-  : Copy to USB storage device.
-  : Open music player.
-  : Search for specific song.

# Music Player

- Music player will launch when playing your songs.
-  : Play music.
-  : Set repeat/shuffle.
-  : Music will continue to play after turning TV screen off.
-  : Change position of music player.
-  : Minimize music player.
-  : Close music player.
-  : View lyrics if applicable.

# Troubleshooting

If you experience problems with your TV, check below for advice. If you don't find a solution here, contact After Sales Support on 1300 002 534.

Problem	Solution
The remote control does not work	<ul style="list-style-type: none"><li>Make sure that the batteries are installed with their poles (+/-) in the correct direction.</li><li>Remove any obstacles between the remote control and remote control sensor on the TV.</li><li>Check if the power indicator at the bottom of the TV blinks when you press the remote's power button.</li><li>If it does not, replace the remote control's batteries.</li><li>Try pointing the remote directly at the remote control sensor from 1.5-1.8m away.</li></ul>
The TV won't turn on	<ul style="list-style-type: none"><li>Make sure that the AC power cord is securely plugged into the wall outlet.</li><li>Check the wall outlet is turned on and the power indicator at the bottom of the TV is lit.</li><li>If using a multi-outlet, check if it is working properly. To check whether a power strip is working properly, plug the TV's power plug directly to a wall outlet and observe its operation.</li><li>Try to power on using the power button on the TV.</li></ul>
There is no picture/sound or distorted picture/sound in DTV mode	<ul style="list-style-type: none"><li>Ensure the antenna cable is securely connected to the TV and to the wall outlet.</li><li>Ensure the input source is set to DTV.</li><li>If "No Signal" is displayed, run Menu &gt; Programmes &gt; Programme Tuning &gt; Auto Tuning</li><li>If some channels are missing, run Menu &gt; Programmes &gt; Programme Tuning &gt; Manual Tuning</li><li>Try a different antenna cable or another TV if possible.</li><li>Move the TV away from electronic equipment or devices that could cause interference.</li><li>Adjust the antenna position.</li><li>If the picture appears fuzzy or blurry, select High Definition (HD) channels or programs.</li></ul>



Problem	Solution
<p>There is no picture/sound or distorted picture/sound from an external device</p>	<p>Ensure that connection to the device is correct and that all cables are fully inserted.</p> <p>Remove and reconnect all cables connected to the TV and the external devices. Try new cables if possible.</p> <p>Restart the connected devices by unplugging each device's power cord and then plugging it in again.</p> <p>If "No Signal" is displayed on the TV, ensure that the correct input source has been selected.</p> <p>When using a 4K playback device, ensure the cable is a High-Speed HDMI cable.</p>
<p>There is no/distorted sound</p>	<p>Ensure the volume is not muted. If it is, press the VOL+ button to restore the sound.</p> <p>If earphones are connected, unplug them.</p> <p>Ensure that connection to the external audio device is correct and that all cables are fully inserted.</p> <p>Ensure correct input source and audio settings have been selected on the external audio device.</p> <p>Move the TV away from electronic equipment or devices that could cause interference.</p> <p>When using an external audio device via a HDMI cable, ensure that the device supports HDMI-ARC and, if applicable, the ARC setting is turned On (refer to the connection guide in the user manual of the connected device).</p> <p>When using an external audio device via an optical cable, check that the Menu &gt; Sound &gt; Sound Out &gt; Select Optical and then Menu &gt; Sound &gt; Additional Settings &gt; Digital Sound Out is set to PCM.</p>
<p>The smart apps are not working properly</p>	<p>Ensure the TV is connected to the Internet.</p> <p>Ensure the TV has a high-speed internet connection to get the best-streaming picture resolution.</p> <p>An unstable internet connection may cause delays or interruptions. In addition, applications may terminate automatically depending on the network environment. If this occurs, check your internet connection and try again.</p>



Problem	Solution
<p>There is no/intermittent internet</p>	<p>When using Wi-Fi, make sure the Wi-Fi password is entered correctly.</p> <p>Turn off the access point. Wait for 2 minutes and then turn them back on.</p> <p>Ensure that there are no obstacles between the TV and the access point. (The Wi-Fi strength can be decreased by appliances, cordless phones, stone walls/fireplaces, etc.) Reduce interference by not using or turning off other wireless devices.</p> <p>If the Wi-Fi connection fails, connect the TV to the access point via a LAN cable. If the TV can connect via the wired connection, there might be a problem with the Wi-Fi access point. In this case, try using a different access point.</p> <p>When using a LAN cable, use one rated CAT 5 or higher. Make sure it is plugged in at both ends.</p> <p>When using a static IP, ensure network addresses are entered correctly.</p> <p>If the problem persists, contact your Internet Service Provider or modem manufacturer.</p>
<p>USB storage device is not recognised or media files don't play properly</p>	<p>This TV has been tested with the majority of Flash memory-based devices and hard disks (media players with HDD) on the market however, it may not be compatible with certain devices.</p> <p>If the external hard drive has its own power adaptor, use it.</p> <p>Only use a USB storage device formatted in a FAT32 file system provided with the Windows operating system. If it is formatted by a different utility program that is not supported by Windows, it may not be recognised.</p> <p>The TV may not be able to recognise a USB device or read the files if it is connected with a USB extension cable</p> <p>The files that use an unsupported codec or container will not play on the TV.</p> <p>Some files may not play correctly if there is an error in the content or container.</p> <p>Certain files, depending on how they are encoded, may not play on the TV.</p>



# Specifications

Active screen size (diagonal)	147 cm	
Resolution	3840 x 2160	
Refresh rate	60Hz	
Aspect ratio	16:9	
Multimedia playback formats (USB mode)	Music	MP3, WAV, FLAC
	Photo	JPG, BMP, PNG
	Video	AVI, MPEG-1, MPEG-2, MPEG-4, MKV
USB output	DC 5V 500mA	
Power source	AC 100-240V, 50/60Hz	
Power consumption	132W Max.	

Dimensions (W x D x H)	With stand: 1307 x 286 x 834 mm	
	Without stand: 1307 x 88 x 765 mm	
Weight	Net	13.3 kg
	Gross	17.3 kg

## For Technical and Warranty Support

1300 002 534

tempo.org

tempo.org/support

Distributed by Tempo (Aust) Pty Ltd,

PO Box 132, Frenchs Forest NSW 1640

The Bluetooth® word mark and logos are registered trademarks owned by Bluetooth SIG, Inc. and any use of such marks by Hands (IP) Holdings Pty Ltd is under license. Other trademarks and trade names are those of their respective owners.

# Compliance and Responsible Disposal



## Packaging

The packaging of your product has been selected from environmentally friendly materials and can usually be recycled. Please ensure these are disposed of correctly. Plastic wrapping can be a suffocation hazard for babies and young children, please ensure all packaging materials are out of reach and are safely disposed of. Please recycle these materials rather than throwing them away.



## Product

At the end of its working life, do not throw this product out with your household rubbish.

An environmentally friendly method of disposal will ensure that valuable raw materials can be recycled. Electrical and electronic items contain materials and substances which, if handled or disposed of incorrectly, could potentially be hazardous to the environment and human health.



## National Television and Computer Recycling Scheme

The careful disposal of e-waste is important because many televisions and computers contain materials which are hazardous to people and the environment. There are no fees for householders or small businesses disposing of e-waste at a scheme collection service.

Individuals can contact their local council for information on local e-waste management services, find scheme services listed on Planet Ark's website at [www.recyclingnearyou.com.au](http://www.recyclingnearyou.com.au), or call Planet Ark on 1300 733 712.

## Compliance

This product complies with the Australian Safety Standard AS/NZS 62368.1 to ensure the safety of the product.





**BAUHN®**

## Warranty Information

The product is guaranteed to be free from defects in workmanship and parts for a period of 12 months from the date of purchase. Defects that occur within this warranty period, under normal use and care, will be repaired, replaced or refunded at our discretion, solely at our option with no charge for parts and labour. The benefits conferred by this warranty are in addition to all rights and remedies in respect of the product that the consumer has under the Competition and Consumer Act 2010 and similar state and territory laws.

Our goods come with guarantees that cannot be excluded under the Australian Consumer Law. You are entitled to a replacement or refund for a major failure and to compensation for any other reasonably foreseeable loss or damage. You are also entitled to have the goods repaired or replaced if the goods fail to be of acceptable quality and the failure does not amount to a major failure.





**BAUHN®**

## **Repair and Refurbished Goods or Parts Notice**

Unfortunately, sometimes faulty products are manufactured, which need to be returned to the supplier for repair.

Please be aware that if your product is capable of retaining user-generated data (such as files stored on a computer hard drive, telephone numbers stored on a mobile telephone, songs stored on a portable media player, games saved on a games console or files stored on a USB memory stick) during the process of repair, some or all of your stored data may be lost. We recommend you save this data elsewhere prior to sending the product for repair.

You should also be aware that rather than repairing goods, we may replace them with refurbished goods of the same type or use refurbished parts in the repair process.

Please be assured though, refurbished parts or replacements are only used where they meet ALDI's stringent quality specifications.

If at any time you feel your repair is being handled unsatisfactorily, you may escalate your complaint. Please telephone us on 1300 002 534 or write to us at:

Tempo (Aust) Pty Ltd ABN 70 106 100 252  
PO Box 132, Frenchs Forest, NSW 1640  
Telephone: 1300 002 534 (Aust) Fax: (02) 8977 3765  
Tempo Help Desk: 1300 002 534 (Aust)  
(Operating Hours: Mon-Fri 8:30am-6pm; Sat 9am-6pm AEST)  
Email: [tempo.org/support](mailto:tempo.org/support)

# Notes

# Notes

## Online support

Visit [bauhn.com.au](http://bauhn.com.au) for software updates to keep your TV up-to-date, as well as the latest User Manual for information on the updated features.

## Warranty returns

Should you for any reason need to return this product for a warranty claim, make sure to include all accessories with the product.

## Product does not work?

If you encounter problems with this product, or if it fails to perform to your expectations, please contact our After Sales Support Centre on 1300 002 534.

ALDI guarantees that our products are developed to our stringent quality specifications. If you are not entirely satisfied with this product, please return it to your nearest ALDI store within 60 days from the date of purchase for a full refund or replacement, or take advantage of our after sales support by calling the supplier's Customer Service Hotline.



### Please read the manual

It will help you get the best out of your product.

### Still have questions?

Call After Sales Support

**1300 002 534**

Or visit [tempo.org/support](http://tempo.org/support)

### AFTER SALES SUPPORT



 AUS 1300 002 534

 [tempo.org/support](http://tempo.org/support)

MODEL: ATV58UHDW-0322 PRODUCT CODE: 708412 03/2022

# 1

YEAR WARRANTY