

**BAUHN®**

**55"**

**4K**

Ultra HD  
Smart TV

MODEL: ATV55UHDS-0920



User Manual



# Welcome

Congratulations on your purchase!

This manual tells you all you need to know about using your new BAUHN® product.

Please take special note of any important safety and usage information presented with the  symbol.

All products brought to you by BAUHN® are manufactured to the highest standards of performance and safety and, as part of our philosophy of customer service and satisfaction, are backed by our comprehensive 1 Year Warranty.

We hope you will enjoy using your purchase for many years to come.

# Contents

Welcome	2	TV Setting Menus	18	Recording	39
Unpack and Prepare	4	TV	20	Recording Live TV	40
What's in the box	4	Picture	21	Scheduled Recording	40
 Important Tips	5	Sound	23	Playback	40
Attaching the stand	6	Network	25	Pause Live TV (Time-shift)	41
Wall-mounting the TV	7	System	27	USB Mode	42
Connect to power	8	Lock	30	Set up	42
Connect your antenna	8	PVR (Personal Video Recording)	31	Troubleshooting	44
Controls and Connections	9	About	32	Specifications	47
Get to know your TV	9	QMenu	33	Compliance and Responsible Disposal	48
Buttons on the TV	9	High Dynamic Range (HDR)	34	Warranty Information	49
Ports on the TV	10	Smart TV	35	Repair and Refurbished Goods or Parts Notice	50
Remote Control	12	Smart TV Applications	35		
Setup	12	Screencast	36		
Using the Remote Control	13	App Portals	36		
Standard Remote	14	Web Browser	37		
Easy Remote	16	TV Guide	38		
On-Screen Set Up	17				

# Unpack and Prepare

## What's in the box

Before installing your new TV, check you have everything needed.

In the box you will find:

- A. 55" 4K Ultra HD Smart TV
- B. Remote Control
- C. Easy Remote Control
- D. AAA Activ Energy Batteries
- E. TV Stands
- F. Screws for TV Stands
- G. Warning Sheet
- H. TV Toppling Safety Message
- I. Quick Start Guide
- J. Warranty Certificate
- K. General Safety Warnings
- L. User Manual

You will need:

- Phillips-head screwdriver (for stand installation)
- Broadband internet (to access Smart TV apps)
- Someone to help you lift and install your TV
- Antenna cable (to watch live TV)



See the top of the box for how to handle the TV without damaging it!

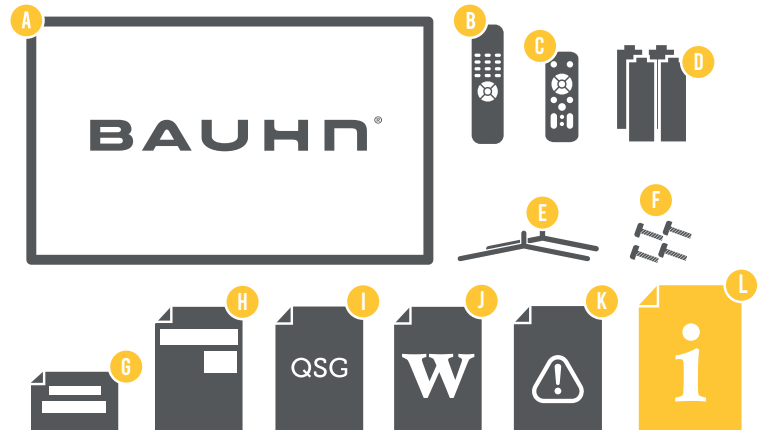

## Important Tips

- Place the TV on a level surface.
- Place the TV away from any source that may generate heat or vibrations.
- Make sure there is enough space around vents for airflow.
- The remote control works up to 5 metres away from the TV.
- Unplug the TV before cleaning it.
- Clean using a dry cloth only - do not use water or chemicals.
- Use only the power supply provided.
- It is highly recommended to use safety straps for securing the TV in place.
- Keep liquid, children and pets away from the TV at all times.

## Attaching the stand

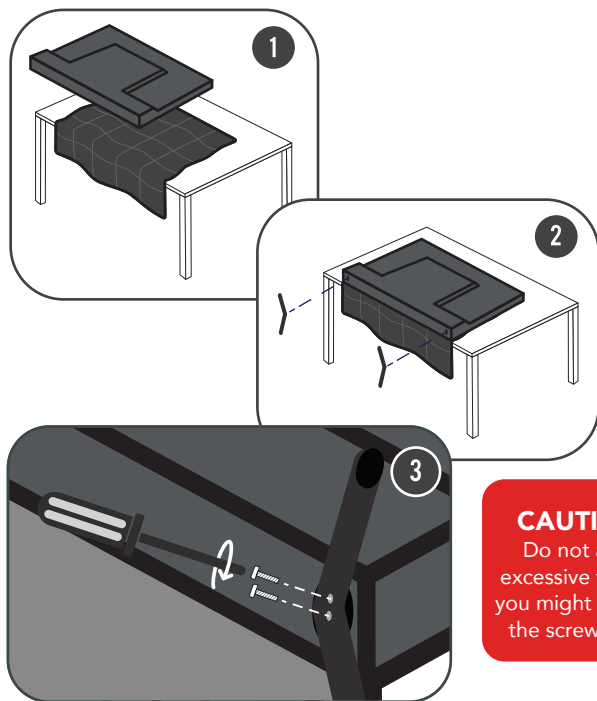

**CAUTION!**  
Do not apply excessive force as you might damage the screw holes.



- This TV is heavy! We recommend asking someone to help you lift it.
- Unplug the TV from the power outlet before installing or removing the stand.
- **DO NOT** place the TV standing upright without its stand attached; it could damage the remote sensor at the bottom of the TV.
- Only touch the frame, not the screen.
- It is highly recommended to use safety straps for securing the TV.

Unless you are wall-mounting the TV, you will need to attach its stand/legs.

1. Lay the TV face-down on a soft, flat surface (like the sofa, or a towel on a table) larger than the TV itself.
2. Match the stands to the installation points on the underside of the TV.
3. Attach the stands to the TV at the installation points using the screws provided. (Grab a screwdriver for this bit).

# Wall-mounting the TV



- Unplug the TV from the power outlet before wall-mounting.
- Contact a professional for assistance with wall-mounting the TV.

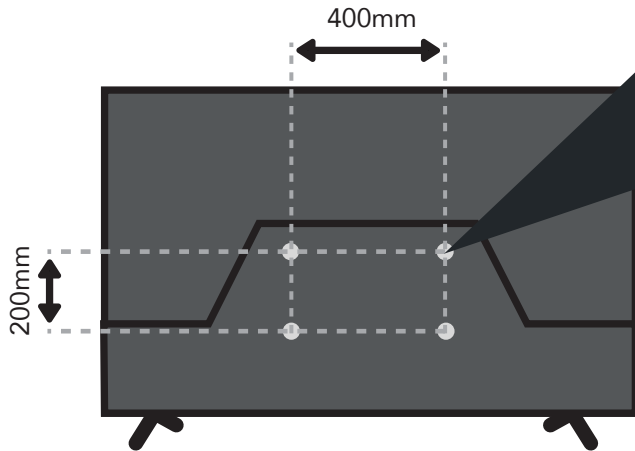

Back of the TV

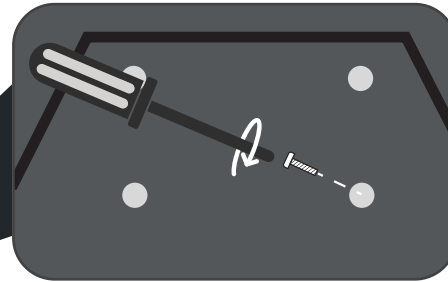

## Required

- VESA Mounting Bracket
- 4 x M6\*10mm screws (or longer as required)

The TV comes with holes on the back panel for use with wall-mounting brackets (bracket not included).

Use four standard M6\*10mm screws (or longer, depending on the mounting bracket) to wall-mount this TV (screws are not included).



The screws in the package are for securing the TV stand only. If you are wall-mounting the TV, consult a qualified installer for advice on bracket support and wall support.

## Connect to power

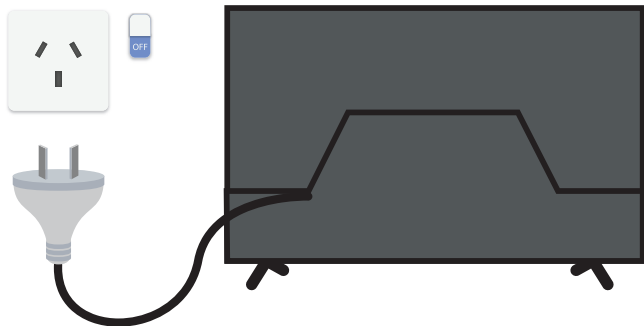

## Connect your antenna

### Free-to-air TV in HD (High Definition)

Example  
HD Channels

ABC HD  
SBS ONE HD  
7HD  
9HD  
10 HD  
PRIME7 HD  
WIN HD

High Definition (HD) channels provide the best viewing quality and are available with a digital antenna connection.

TV channels in Ultra HD resolution are not currently available in Australia. Therefore when you watch HD broadcast signals on an Ultra HD TV, the picture can appear 'soft' and lacks the detail you see when watching the same content on a HD TV.



Don't forget to plug in the TV to the power outlet. Leave the power switched off until installation is finished.



Make sure the TV is **switched off** at the power outlet until you have finished connecting your cables.

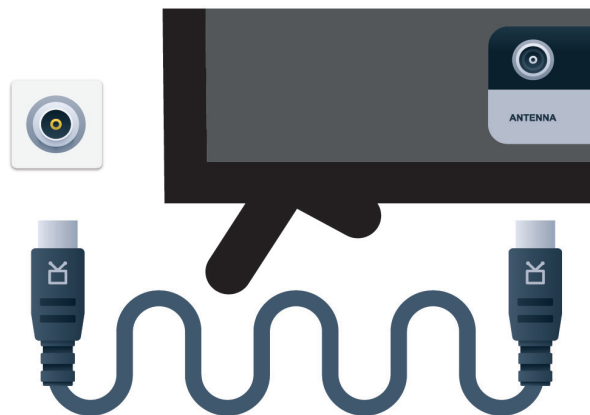

Antenna cable not included.



# Controls and Connections

## Get to know your TV



## Buttons on the TV

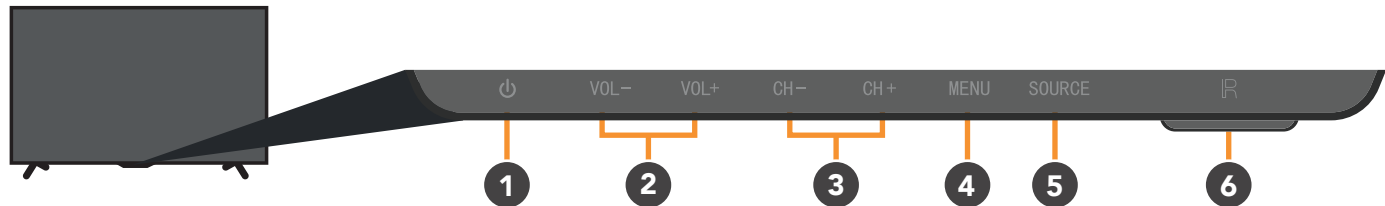





1.  $\text{⏻}$  (ON/Standby): Switch the TV to On or Standby.
2. VOL - / VOL + : Decrease/increase the volume level.
3. CH - / CH + : Select the previous or next channel.
4. Menu: Enter the settings menu.

5. SOURCE: Select the input source.
6. IR remote receiver.

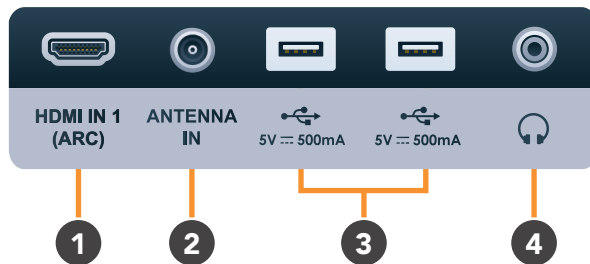





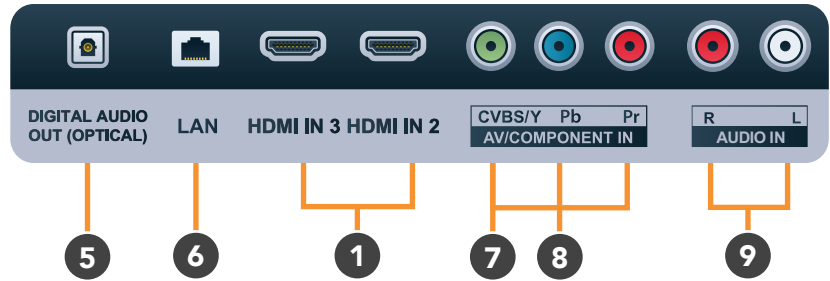
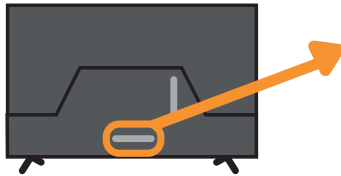

See next page for more info on the connections. 

# Ports on the TV



1	<b>HDMI IN</b> Use a high-speed HDMI cable for best picture and sound quality.		SOUND PICTURE COMPUTER	All-digital connection between the TV and any HDMI device. Supports Ultra HD resolution. Requires a high-speed HDMI cable (not included).
2	<b>ANTENNA IN</b>		FREE-TO-AIR TV	Connect your antenna for live TV. (Antenna cable not included).
3	<b>USB</b>		STORAGE	Plug in a USB stick/driver to PVR record and pause live TV. Play media files stored on your USB storage device (supports Ultra HD resolution; supported file codecs and extensions may vary). Update the TV software via USB.
4	<b>Headphone Jack</b>		SOUND	Connect to your headphones, amplifier or audio device, using an AUX cable (not included).

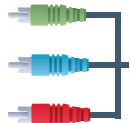

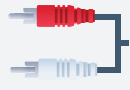
5	DIGITAL AUDIO OUT (OPTICAL)	 	SOUND	Connect an external digital audio device. Use an Optical cable (not included) to connect the unit with an amplifier, soundbar or other audio decoding device for digital audio signal output.
6	LAN	 	INTERNET	Connect to your broadband modem using an Ethernet cable (not included) for best streaming experience. However, the TV also has built-in wifi.
7	AV IN	  CVBS/Y	PICTURE	You can use this to connect your DVD player. Supports Standard Definition (SD) resolution. Requires an AV cable (not included).
8	Component IN	 	PICTURE	You can use this to connect your DVD player. Supports Full High Definition (FHD) resolution. This also requires a component cable (not included).
9	AUDIO IN	 	SOUND	You can use this to connect Audio to your TV for AV or Component video inputs. Requires an AV cable (not included).

# Remote Control

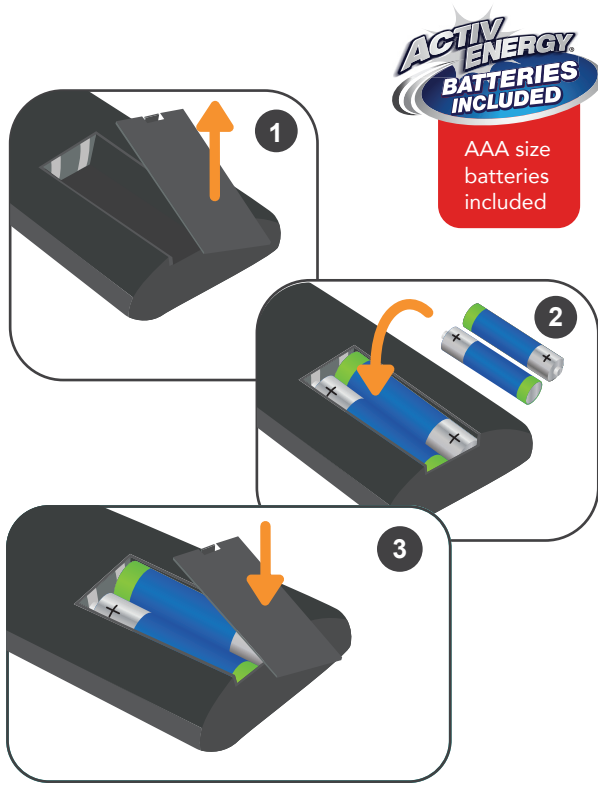

## Setup

Insert two AAA size batteries according to the polarity markings (+ / -) inside the compartment. Make sure the batteries are correctly aligned and properly pushed into place.



### Precautions When Using Batteries

- Do not use old and new batteries together.
- Do not use different types of batteries (e.g. Manganese and Alkaline batteries) together.
- Remove the batteries from the remote if you do not intend to use it for a long time.
- When discarding used batteries, follow any guidelines for recycling and disposal of batteries that apply in your local area.
- Keep batteries away from children and pets.
- Never throw batteries into a fire or expose them to extreme heat.

# Using the Remote Control

To use the remote, point it towards the remote sensor at the front of the TV. The remote will not operate if its path is blocked.

The remote has a range of up to about 5 metres from the TV at an angle of up to 30 degrees to either side of the sensor, as illustrated below.

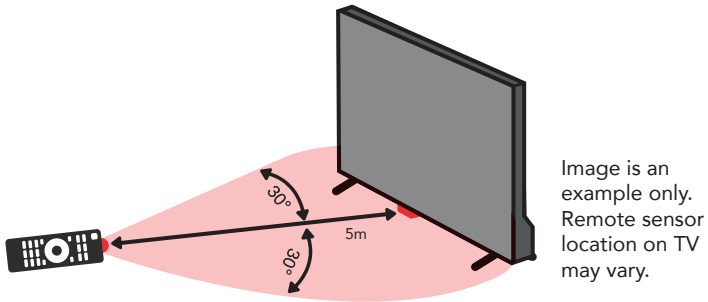

## Remote Hints and Tips

- Do not drop, step on or otherwise impact the remote control. This may damage the parts or lead to malfunction.
- Do not place objects between the remote control and the remote sensor.
- Do not use this remote control while simultaneously operating a remote control for other devices.

# Standard Remote

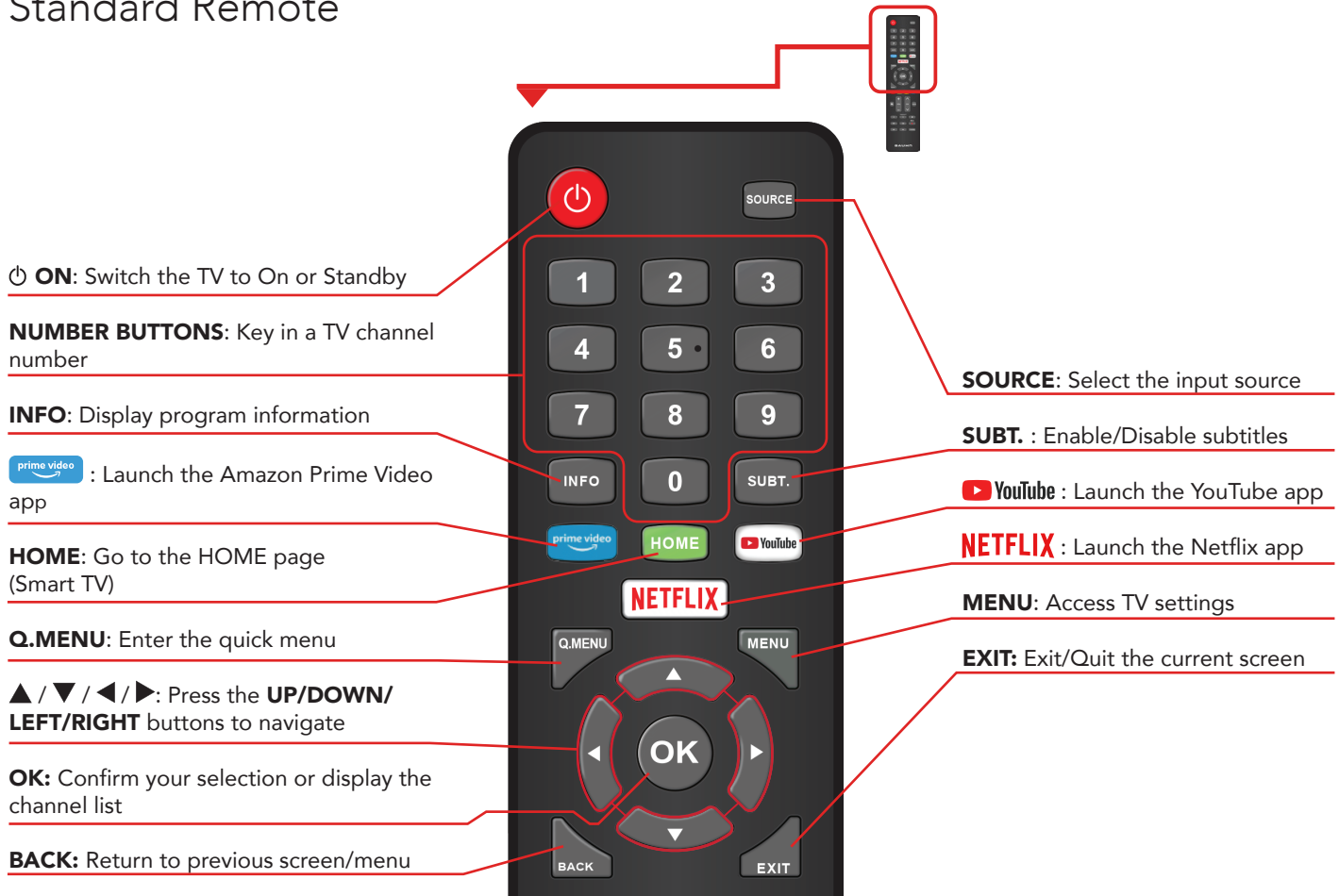

**RED / GREEN / YELLOW / BLUE** RED/GREEN/  
YELLOW/BLUE: Functions are  
according to the on-screen display

**Speaker icon** : Mute or restore sound

**+ VOL -** : Turn the volume up or  
down

**▶** : Play selected video

**◀◀** : Restart current track

**◀◀** : Rewind the track

**▶▶** : Fast forward the track

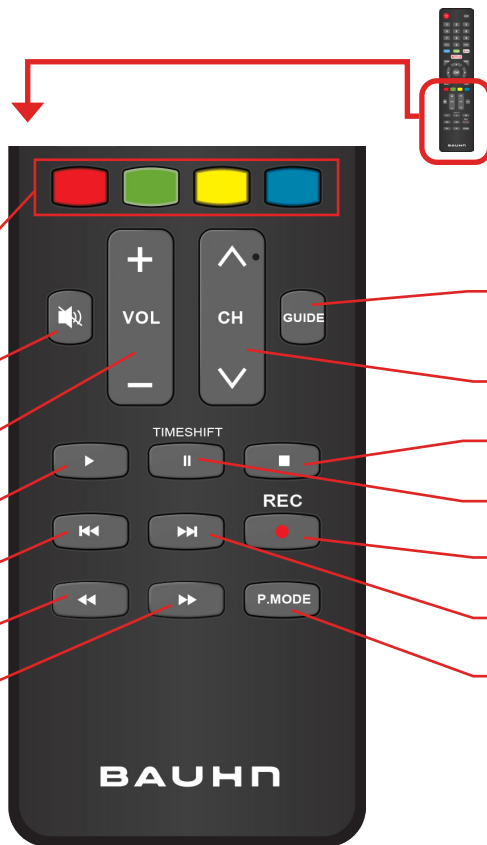

**GUIDE** : Launch TV Guide

**^ CH v** : Go to the next or  
previous channel

**■ (STOP)** : Stop playback

**II / TIMESHIFT** : Pause live TV

**●/REC** : Record live TV

**▶▶** : Skip the current track

**P.MODE** : Enter Picture Mode

# Easy Remote

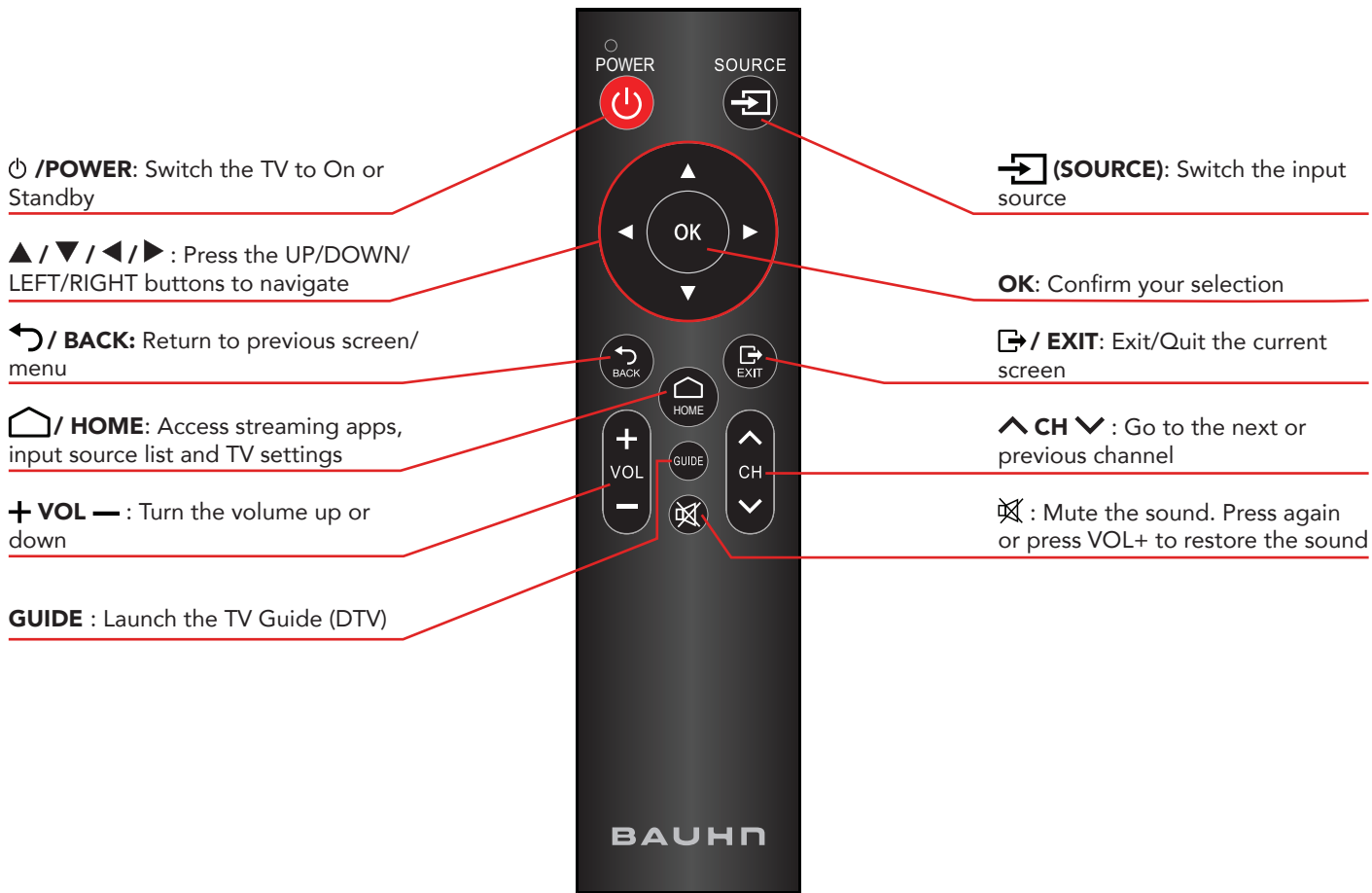



# On-Screen Set Up



Make sure equipment is properly connected (as shown on pages 10-11) before connecting the TV to power.

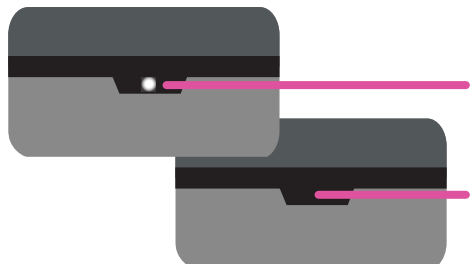

On/Standby light is WHITE in standby mode.

On/Standby light is OFF when the TV is on.

## First Time Setup menu

When you turn the TV on for the first time, the First Time Setup menu will appear.

Follow the prompts using the ▲ / ▼ / ◀ / ▶ / OK buttons to select your preferences. You will be guided through:

1. Language
2. Data Collection and Firmware Update
3. Set Time
4. Usage Mode
5. Connect to the Internet
6. Sign into Netflix
7. Select Input Source
8. Scan Channels

If you make an error, you can update your preferences in the settings menu later.

Note: If you choose to setup Netflix or select an input source other than DTV, the set up wizard will exit and will not let you tune TV channels. To tune channels, go to Menu>TV>Auto Scan.

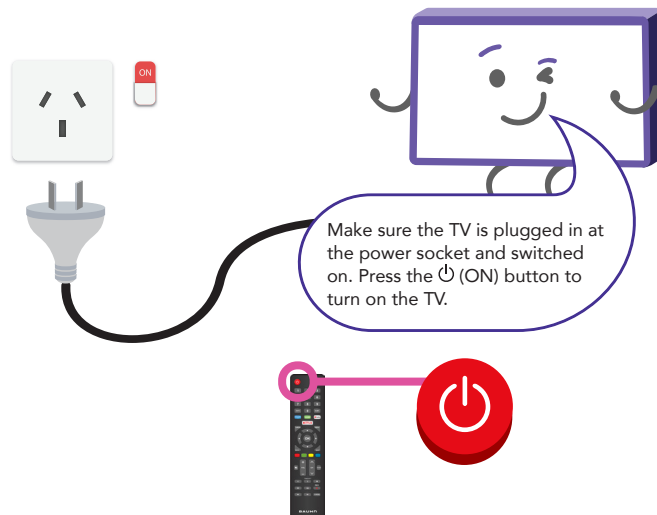

## 5. Connect to the Internet

If you are using a wired network, connect an ethernet cable to the TV; select 'Wired Network' and 'Connect'. The TV will automatically connect to the Internet.

If you are using a wireless connection, select 'Wi-Fi Network'. The TV will scan for nearby wireless networks. Make sure that the TV is within the range of your wireless modem/router, and you have your Wi-Fi password handy. Select your network, enter network password using the on-screen keyboard and select ENTER. Press OK to connect.

Or, you can connect to the internet later by going to the User Menu settings.

# TV Setting Menus

## Menu Navigation Buttons

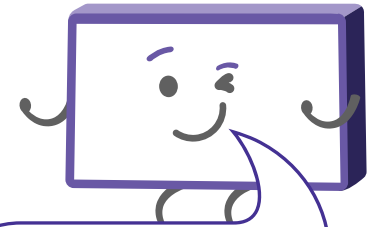
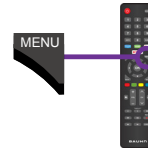

Press the **MENU** button to display the TV settings menu. See the guide below for all the other buttons you'll need to use to adjust and change your settings.

Function	Remote Button
Display the quick menu	<b>Q.MENU</b>
Display the main menu	<b>MENU</b>
Enter a sub menu	▶ OR <b>OK</b>
Adjust a value	▲ / ▼ / ◀ / ▶
Return to the previous menu	<b>MENU</b>
Exit a menu	<b>EXIT</b>



Once you have programmed any settings, the unit will retain them in its memory until you change them, even after turning the TV off.

## Menus Index

 TV	20
<ul style="list-style-type: none"><li>• Auto Scan</li><li>• DTV Manual Scan</li><li>• ATV Manual Scan</li><li>• Signal Information</li></ul>	
 Picture	21
<ul style="list-style-type: none"><li>• Picture Mode</li><li>• Contrast</li><li>• Brightness</li><li>• Saturation</li><li>• Sharpness</li><li>• Tint</li></ul>	

- Aspect Ratio
- Backlight
- Colour Temperature
- HDR
- Noise Reduction

 Sound 23

- Sound Mode
- Equalizer
- Balance
- AVL (Auto Volume Limit)
- Surround Sound
- Dolby Audio Process
- AD Switch
- Digital Output Type
- Audio Type
- Audio Delay
  - S/PDIF Delay
  - Speaker Delay
  - HDMI-ARC Delay

 Network 25

- WiFi: Auto Scan, Manual Input
- Wired: Configuration, Connect
- Wake on LAN
- Wake on WLAN

 System 27

- Language
- OSD Time
- HDMI-EDID
- HbbTV
- HDMI-CEC
  - HDMI-CEC
  - HDMI-ARC (Audio Return Channel)
    - Auto Power On
    - Auto Standby
- Time
- Reset
- Usage Mode

 Lock 30

- Lock System
- Set Password
- Parental Lock

 PVR  
(Personal Video Recording) 31

- PVR File System: (Select Disk, Select Partition, Time Shift Size, Format, Speed)
- Start Record
- Start Timeshift
- Recorded Files

 About 32

- Netflix: (Netflix Deactivate, Terminate Netflix, Netflix ESN, Netflix Version)
- View End-User License Agreement
- System Information
- NetReady Information
- Software Update (USB)
- Internet Update Check

 QMenu 33

- Picture Mode
- Sound Mode
- Aspect Ratio
- Sleep Timer

 High Dynamic Range (HDR) 34

TV



## Option

## Description

Auto Scan

Automatically scans all available free-to-air TV channels. Adjust settings (default settings are set for Australia), select 'Search' and press OK.

DTV Manual Scan

Manually select and scan digital TV channels.

ATV Manual Scan

Manually select and scan analog TV channels. (Analog TV is no longer supported in Australia).

Signal Information

Display current signal information (DTV mode only).

# Picture



## Picture Mode

**Home** : Picture settings for general viewing purposes.

**Bright Room** : Brighter and clearer picture settings for bright viewing environments.

**Dynamic** : Brighter and clearer picture settings for ultra bright viewing environments such as store fronts.

**Personal** : Adjust settings to best suit your viewing environment and content.

### Personal Mode settings

Option	Description
Contrast	Adjust the contrast of the bright and dark areas of the picture. The closer to 100, the higher the contrast.
Brightness	Adjust the overall screen brightness. The closer to 100, the brighter the picture.
Saturation	Adjust the saturation. The closer to 100, the deeper the colour.
Sharpness	Adjust the sharpness of the picture. The closer to 100, the sharper and clearer the image.
Tint	Adjust the colour balance between red and green. (Only available with NTSC video standard. Australia uses PAL video standard).

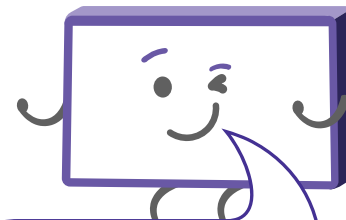

To adjust the brightness, change the Picture Mode to Personal and modify the Brightness setting.

## Aspect Ratio

This item is used to adjust the video size. Sizes may differ between input sources.

## Backlight

Adjust the screen brightness by adjusting the backlight. The closer to 100, the brighter the screen.

### Option

### Description

Colour  
Temperature

Adjust the on-screen colour temperature.

HDR

Select high-dynamic range setting (TV must be receiving an HDR signal for this setting to be active.)

Noise  
Reduction

Reduces screen noise/static.

# Sound

Option	Description
Sound Mode	<b>Standard</b> <b>Music</b> <b>Movie</b> <b>Sport</b> <b>Personal</b>
Equalizer	Adjust selected frequencies. These options are available when sound mode is set to personal.
Balance	Adjust the audio output between the left and right speakers.
AVL (Auto Volume Limit)	Adjust the increase or decrease of audio when you change channels, video sources or content.
Surround Sound	Adjust surround sound effect from your TV speakers.
Dolby Audio Process	Turn the Dolby Audio Process On/Off.
AD Switch	Audio Description (AD) provides an additional audio track for visually challenged persons (DTV only, subject to program).

Digital Output Type      Select digital output type.

Audio Type      Select audio type.

Audio Delay

S/PDIF Delay: Synchronize the sound from the external speakers (when using Optical Audio Out connection) with the TV picture.

Speaker delay: Synchronize the sound from the TV speakers with the TV picture.

HDMI-ARC delay: Synchronize the sound from the external speakers (when using HDMI-ARC connection) with the TV picture.

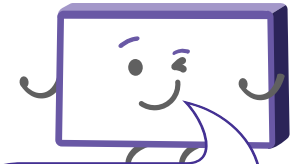

See page 28 for details on  
HDMI-CEC Setup for this TV.



# Network

You can set up your TV so that it can access the Internet through your home network using a wired or wireless connection.

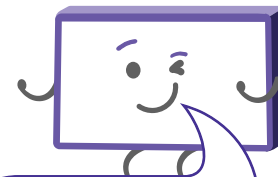

Make sure you have an ethernet cable connected to the TV

Option	Description
Wi-Fi	See below for more information.
Wired	See next page for more information.
Wake on LAN	Turn On/Off Wake On LAN function.
Wake on WLAN	Turn On/Off Wake On WLAN function.

## Wireless Network Settings

Option	Description
Auto Scan	Scan and display nearby available networks.
Manual Input	Manually enter SSIS (network name), password, security mode to connect to a hidden network.

## Wired Network Settings

Option	Description
Configuration	DHCP: Automatically receive network addresses from the W-Fi router. Static: Manually enter IP, Netmask, Gateway, DNS network addresses.
Connect	Select to connect.

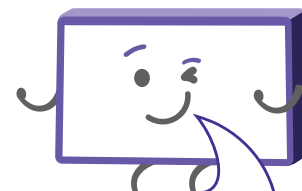

Keep it simple for easy setup!  
If an item isn't required, just  
leave it on the default setting.

# System



Option	Description
Language	Select your preferred On screen display, Audio and Subtitle language.
OSD Time	Set the preferred amount of time for the OSD to be displayed on the screen.
HDMI-EDID	Auto, 1.4 (2K), 2.0 (4K). Select 2.0 (4K) when the source signal is transferred by HDMI 2.0 Specification. Select 1.4 (2K) when the source signal is transferred by HDMI 1.4 Specification.
HbbTV	Switch the HbbTV function On or Off. (Not supported).
HDMI CEC	See the next page for information.
Time	See page 29 for more information.
Reset	Restore the system settings to the factory default. When the restore is complete, the TV will restart.
Usage Mode	Home mode (recommended) is for general home viewing. Store mode is for in-store demo purposes.



## HDMI-CEC

This feature allows for your TV and your connected HDMI device to be controlled by one remote control. It also means you can turn them both on or off simultaneously.

Make sure to select the correct HDMI input source.

Option	Description
HDMI-CEC	Turn HDMI-CEC On/Off.
HDMI-ARC (Audio Return Channel)	If this function is enabled, sound from the TV can be sent to a HDMI-ARC supported external audio device.
Auto Power On	When this is set to On, turning on the TV will also turn on the connected device.
Auto Standby	When this is set to On, turning off the TV will also turn off the connected device.



Not all HDMI cables are the same! Be sure to use a high-speed HDMI cable.

## Time

Option	Description
Auto Sync	On: Automatically syncs TV clock according to the DTV broadcasting time. Off: Manually adjust the clock.
Clock	Displays the DTV signal time or set the time manually.
Off Time	Set the time and day to turn off the TV.
On Time	Set the time and day to turn on the TV.
Sleep Timer	Select the desired Auto Sleep (Standby) duration.
Auto Sleep	Sets the time when the TV will enter Standby mode due to inactivity.
Time Zone	Adjust your timezone.



# Lock



Enter the factory password '0000' using the number buttons on the remote and select 'OK' on-screen. If you changed your password but forgot it, you can still use the master password.



Factory Password: 0000  
Master Password: 4711

Option	Description
Lock System	Turn system lock on/off.
Set Password	Enter the old password, then enter your new password twice. Select 'OK' on-screen to confirm.

## Parental Lock



This item is used to block access to specific program ratings. See options below.

No Block

Block G  
and above

Block PG  
and above

Block M  
and above

Block MA  
and above

Block AV  
and above

Block R  
and above

Block All

Unrestricted



General



Parental guidance recommended



Recommended for mature audiences



Not suitable for people under 15. Under 15s must be accompanied by a parent or adult guardian

Not suitable for people under 15. Under 15s must be accompanied by a parent or adult guardian



Restricted to 18 and over

Restricted

# PVR (Personal Video Recording)

To make changes to PVR (Personal Video Recording), ensure your USB drive is inserted into the TV. Check the troubleshooting section if you're having problems setting up your USB device.

Option	Description
PVR File System	<p>Enter submenu in DTV mode.</p> <ul style="list-style-type: none"><li>• Select Disk: Select the USB drive</li><li>• Select Partition: Select the disk partition if there are any multiple partitions on the disk.</li><li>• Time Shift Size: Select the memory size for the Time Shift function. Options: 512MB, 1GB, 2GB, 4GB.</li><li>• Format: Format the connected USB.</li><li>• Speed: Checks the speed of the storage device.</li></ul>
Start Record	Start recording.
Start Timeshift	Start Timeshift function.
Recorded Files	View list of recorded files.

# About



Option	Description
Netflix	Enter Netflix submenu. <ul style="list-style-type: none"><li>• Netflix Deactivate: Select to deactivate Netflix.</li><li>• Terminate Netflix: Select to terminate Netflix.</li><li>• Netflix ESN: Display the Netflix ESN information.</li><li>• Netflix Version: Display the Netflix version.</li></ul>
View End-User License Agreement	Read and accept/decline the End-User-License Agreement (EULA).
System Information	Display system information.
NetReady Information	Display current software version information.
Software Update (USB)	Update the TV software via USB.
Internet Update Check	Update the software using the internet.



# QMenu

The QMenu gives you access to selected menu settings without the hassles of navigating through the full menu. Press the Q.MENU button once on your remote to access this.

Option	Description
Picture Mode	Select the picture best suited to the content you are viewing.
Sound Mode	Select the sound mode best suited to the content you are viewing.
Aspect Ratio	Adjust the video size. The available video size may be different for different input source.
Sleep Timer	Select the desired Auto Sleep (Standby) duration.



# High Dynamic Range (HDR)

HIGH DYNAMIC RANGE

## About the HDR feature

High Dynamic Range (HDR) is a picture feature on your TV that attempts to mimic the way visuals are perceived in real life by the human eye.

By using this feature, the TV can reproduce greater dynamic range of luminosity by capturing and then combining several different exposures.

HDR promises better picture quality thanks to brighter, more realistic highlights, more realistic colour and other improvements.

It delivers the look that the filmmakers intended to achieve, showing the hidden areas of dark shadows and sunlight with full clarity, colour and detail.

## HDR on your TV

HDR is supported in HDMI and USB input sources and by Netflix app.

When the TV is displaying HDR media, the information banner (press the INFO button on the remote) will display 'HDR'.



**NOTE:** When watching HDR content, make sure the Menu > System > HDMI-EDID setting is set to 2.0 (4K). This requires an HDR playback-capable external media player and HDR optimised media content. Use a High-Speed HDMI cable when connecting to an external media player.

# Smart TV

Before you start using apps, your TV must be connected to the internet.

The speed of your internet connection determines the quality of your audio/video experience when you watch streaming content.

Accessing internet content may count towards your download limit and may incur fees from third parties such as your internet service provider (ISP).

Function	Remote Button
Display the Home/App screen	
Select different Apps	
Open your desired App	

## Smart TV Applications

- Netflix
- YouTube
- Amazon Prime Video
- NetRange Smart TV Apps
- Facebook
- Twitter
- Yahoo! Weather
- Screencast
- Toon Goggles
- YouTube Kids
- Homeshare
- Web Browser



You cannot download any extra apps on this TV.

## NETFLIX

Netflix is a streaming service that offers unlimited viewing of a wide variety of award-winning TV shows, movies and documentaries.

A paid subscription is required.

This TV can play Netflix content in 4K Ultra HD HDR resolution, however the playback resolution may be lower depending on your subscription level and your network speed.

Streaming Netflix content will count towards the data usage of your broadband plan.

## Screencast

The Screencast feature enables you to echo the display from a compatible Android device like a smartphone or tablet on the TV screen by connecting your mobile device directly to the TV wirelessly. In order to use this feature, your device must support Wi-Fi Display technology.



Apple iOS operating system is not supported.

To start using the Screencast feature, select the Screencast icon and press OK to load the app.

Turn on Wi-Fi and Wireless Display (a.k.a. Wi-Fi Display, Wi-Fi Direct, Cast Screen) function on your smart phone or tablet (Please refer to your device's user manual for information on how to turn on wireless display).

Your mobile device will display a list of available devices. Choose "Screencast" and click on it to connect.

Your mobile device will connect to the TV and will display the device screen on the TV.

Use your device to disconnect.

## App Portals

The NetRange app portal gives you access to other content and service providers.

Some apps may require a paid subscription.

Streaming content will count towards the data usage of your broadband plan.

# Web Browser

Using the web browser, you can surf the Internet on the TV similar to how you would do on a PC.

NOTE: Use a wired or wireless keyboard and mouse (not provided) for an easier web browsing experience.

From the Home page, select a recommended or bookmarked site and click **OK** to visit the site.

Press the **RED** / **RED** button to bring out the address bar.

Press the **OK** button on the address bar to type the web address. You can enter the web address using the on-screen keyboard, remote keyboard or connected wireless keyboard.

Select the 'Add to bookmark' icon and press **OK** to add the web address as a favourite.

Select the 'Settings' icon to access the browser menu settings.

Press the **EXIT** to exit the web browser.

## On-screen keyboard

Use **▲/▼/◀/▶** buttons and press **OK** to enter the character.

Use **GREEN** / **GREEN** and **YELLOW** / **YELLOW** buttons to move the cursor left and right.

Press **RED** / **RED** button to enter.

Press **BLUE** / **BLUE** button to delete (backspace).

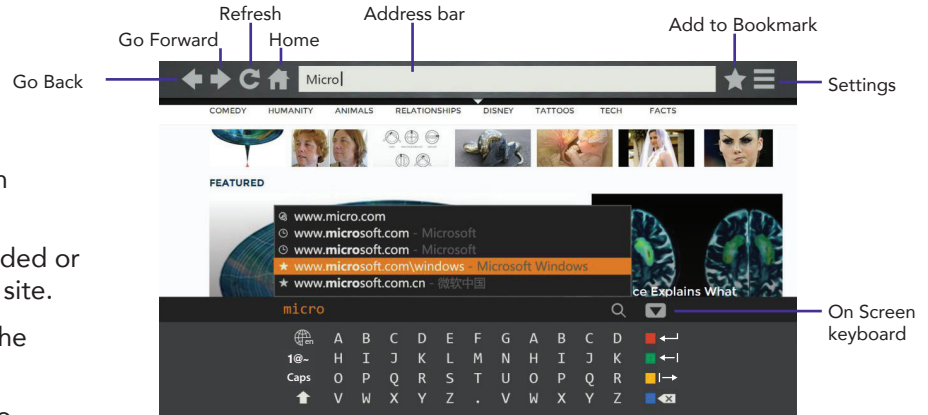

# TV Guide

(Free to air TV)

## TV Guide Functions

Function	Remote Button
Switch between TV Guide/ Schedule List, Channel List and Program List	◀/▶
Browse Channel List and Program List	▲/▼
View program information, schedule for recording or reminder	OK
Exit TV Guide menu	EXIT

To access the TV guide, press the **GUIDE** button on the remote.

To activate the TV Channels use the ▲ / ▼ buttons to select a channel in the left column, then press **OK** to confirm.



# Recording

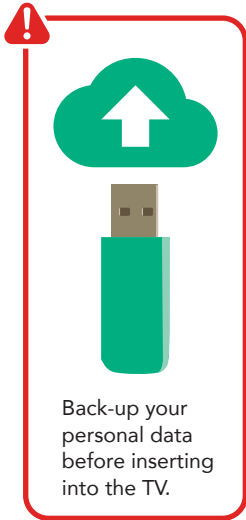

## Important Tips:

- Back-up your personal data before plugging in your USB to the TV. We do not assume liability for any loss of data due to misuse or malfunction.
- You cannot change channels while in recording mode.
- If the signal is interrupted while in recording mode, the recording will stop until the signal is established.
- Do not turn the TV off while it is in time-shift mode.
- The file recorded can only be used on this TV. Do not copy it to any other device.
- When connecting or disconnecting the USB storage device, ensure the TV is not in USB mode, otherwise the USB device or the files stored on it may be damaged.





Before you can record with this TV (including time-shift recording), you must insert your USB storage device into the USB port.



Recording, scheduled recording and pause live TV functions only work in DTV mode (free-to-air).

## Recording Live TV

### Start Recording

Press **●/REC** once, then **OK** to start recording.

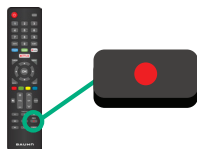

### Stop Recording

Press **■ (STOP)** once - display the dialogue box.

Select **YES** to stop recording.

Select the **NO** button to continue recording.

## Playback

Press the **MENU** button then navigate to System then PVR File System then Record List to display the list of recorded programs.



Use the **▲ / ▼** buttons to select a recorded file.

Press the **OK** button to start playback in Full Screen Mode.

## Scheduled Recording

See TV Guide Functions on page 38 to schedule recordings and view schedules.



When a program is being recorded in the background (while the TV is in standby mode), the Standby/On light will flash white.



# Pause Live TV (Time-shift)

Temporarily pause the live TV signal, then resume playback at your convenience.



Before you can record with this TV (including time-shift recording), you must insert your USB storage device into the USB port.



## Start Time-shift

Press the **|| / TIMESHIFT** button on the remote to enter time-shift mode.

Press the **▶** button to resume playing the program.

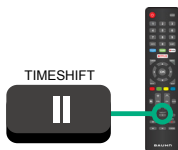

## Stop Time-shift

Press the **■ (STOP)** button to exit time-shift.



The USB storage device won't retain recorded data after you exit the time-shift function.



# USB Mode

## Set up

Insert your USB into a USB port on the TV.

Press the **SOURCE** button to select 'USB' mode.

Function	Remote Button
Choose a Source or File	◀ / ▶ / ▲ / ▼
Choose media categories	▲ / ▼
Start playing your media	OK
Return to previous screen	EXIT
Exit media mode	EXIT



You can only play Photos in the Photo category and Music in the Music category. Make sure you select the correct category for the file you wish to play.



## Playback Functions

Playback of different media types have different controls.

### Photo

Function	Remote Button
Navigate to a folder or file	◀/▶/▲/▼
Display your photo	OK
Display the on-screen toolbar	OK
Hide the on-screen toolbar	BACK
Change advanced settings	MENU
Return to file list	EXIT

### Music

Function	Remote Button
Navigate to a folder or file	◀/▶/▲/▼
Play your track	OK
Fast forward or rewind the track	◀◀/▶▶
Skip or restart the current track	◀◀/▶▶
Change advanced settings	MENU
Return to file list	EXIT

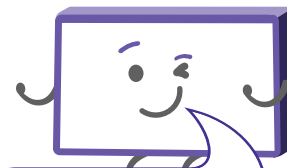

Only supported file types will be displayed. See the specifications table for supported file types.

# Troubleshooting

If you experience problems with your TV, check below for advice. If you don't find a solution here, contact After Sales Support on 1300 886 649.

Problem	Solution
The remote control does not work	<ul style="list-style-type: none"><li>Make sure that the batteries are installed with their poles (+/-) in the correct direction.</li><li>Remove any obstacles between the remote control and remote control sensor on the TV.</li><li>Check if the power indicator at the bottom of the TV blinks when you press the remote's power button.</li><li>If it does not, replace the remote control's batteries.</li><li>Try pointing the remote directly at the remote control sensor from 1.5-1.8m away.</li></ul>
The TV won't turn on	<ul style="list-style-type: none"><li>Make sure that the AC power cord is securely plugged into the wall outlet.</li><li>Check the wall outlet is turned on and the power indicator at the bottom of the TV is lit.</li><li>If using a multi-outlet, check if it is working properly. To check whether a power strip is working properly, plug the TV's power plug directly to a wall outlet and observe its operation.</li><li>Try to power on using the power button on the TV.</li></ul>
There is no picture/sound or distorted picture/sound in DTV mode	<ul style="list-style-type: none"><li>Ensure the antenna cable is securely connected to the TV and to the wall outlet.</li><li>Ensure the input source is set to DTV.</li><li>If "No Signal" is displayed, run Menu &gt; TV &gt; Auto Scan to search for channels.</li><li>If some channels are missing, run Menu &gt; TV &gt; Auto Scan or manually search by Menu &gt; TV &gt; DTV Manual Scan.</li><li>Try a different antenna cable or another TV if possible.</li><li>Move the TV away from electronic equipment or devices that could cause interference.</li><li>Adjust the antenna position.</li><li>If the picture appears fuzzy or blurry, select High Definition (HD) channels or programs.</li></ul>



Problem	Solution
<p>There is no picture/sound or distorted picture/sound from an external device</p>	<p>Ensure that connection to the device is correct and that all cables are fully inserted.</p> <p>Remove and reconnect all cables connected to the TV and the external devices. Try new cables if possible.</p> <p>Restart the connected devices by unplugging each device's power cord and then plugging it in again.</p> <p>If "No Signal" is displayed on the TV, ensure that the correct input source has been selected.</p> <p>If you are using a 4K playback device, ensure the cable is a High-Speed HDMI cable and adjust Menu &gt; System &gt; HDMI-EDID setting.</p>
<p>There is no/distorted/delayed sound</p>	<p>Ensure the volume is not muted. If it is, press the VOL+ button to restore the sound.</p> <p>If earphones are connected, unplug them.</p> <p>Ensure that connection to the external audio device is correct and that all cables are fully inserted.</p> <p>Ensure correct input source and audio settings have been selected on the external audio device.</p> <p>Move the TV away from electronic equipment or devices that could cause interference.</p> <p>If you are using an external audio device via a HDMI cable, ensure that the device supports HDMI-ARC and, if applicable, the ARC setting is turned On (refer to the connection guide in the user manual of the connected device). Ensure on the TV, Menu &gt; System &gt; HDMI-CEC &gt; HDMI-ARC setting is turned On.</p> <p>If you are using an external audio device via an optical cable, check that the Menu &gt; Sound &gt; Digital Output Type settings is set to "PCM".</p> <p>Adjust the Menu &gt; System &gt; HDMI-EDID setting.</p> <p>If the TV sound is not synchronised with the picture, adjust the applicable Menu &gt; Sound &gt; Audio Delay setting.</p>



Problem	Solution
<p>There is no/ intermittent internet</p>	<p>If you are using Wi-Fi, make sure the Wi-Fi password is entered correctly.</p> <p>Turn off the access point. Wait for 2 minutes and then turn them back on.</p> <p>Ensure that there are no obstacles between the TV and the access point. (The Wi-Fi strength can be decreased by appliances, cordless phones, stone walls/fireplaces, etc.) Reduce interference by not using or turning off other wireless devices.</p> <p>If the Wi-Fi connection fails, connect the TV to the access point via a LAN cable. If the TV can connect via the wired connection, there might be a problem with the Wi-Fi access point. In this case, try using a different access point.</p> <p>If you are using a LAN cable, use one rated CAT 5 or higher. Make sure it is plugged in at both ends.</p> <p>If you are using a static IP, ensure network addresses are entered correctly.</p> <p>If the problem persists, contact your Internet Service Provider or modem manufacturer.</p>
<p>USB storage device is not recognised or media files don't play properly</p>	<p>This TV has been tested with the majority of Flash memory-based devices and hard disks (media players with HDD) on the market however, it may not be compatible with certain devices.</p> <p>If the external hard drive has its own power adaptor, use it.</p> <p>Only use a USB storage device formatted in a FAT32 file system provided with the Windows operating system. If it is formatted by a different utility program that is not supported by Windows, it may not be recognised.</p> <p>The TV may not be able to recognise a USB device or read the files if it is connected with a USB extension cable</p> <p>The files that use an unsupported codec or container will not play on the TV.</p> <p>Some files may not play correctly if there is an error in the content or container.</p> <p>Certain files, depending on how they are encoded, may not play on the TV.</p> <p>Sound may not work if they have standard bit rates/frame rates above the TV's compatibility ratings.</p>



# Specifications

<b>Active screen size (diagonal)</b>	138.5cm	
<b>Resolution</b>	3840 x 2160	
<b>Refresh rate</b>	60Hz	
<b>Aspect ratio</b>	16:9	
<b>Multimedia playback formats (USB mode)</b>	Video	3GP, HDR, H265, H264, MKV, MP4, MPEG-2, TP, TS, MPG, MPEG
	Music	AAC, M4A, OGG, MP3
	Photo	JPEG, JPG, BMP, PNG, GIF
<b>USB output</b>	DC 5V 500mA	

<b>Power source</b>	AC 100-240V, 50/60Hz	
<b>Power consumption</b>	138W	
<b>Dimensions (W x D x H)</b>	With stand: 1239.5 x 223.8 x 778.2 mm	
	Without stand: 1239.5 x 90.3 x 727 mm	
<b>Weight</b>	Net	12.3 kg
	Gross	17.4 kg

## For Technical and Warranty Support

1300 886 649

[www.tempo.org](http://www.tempo.org)

[info@tempo.org](mailto:info@tempo.org)

Distributed by Tempo (Aust) Pty Ltd,

PO Box 6056, Frenchs Forest DC 2086



# Compliance and Responsible Disposal



## Packaging

The packaging of your product has been selected from environmentally friendly materials and can usually be recycled. Please ensure these are disposed of correctly. Plastic wrapping can be a suffocation hazard for babies and young children, please ensure all packaging materials are out of reach and are safely disposed of. Please recycle these materials rather than throwing them away.



## Product

At the end of its working life, do not throw this product out with your household rubbish.

An environmentally friendly method of disposal will ensure that valuable raw materials can be recycled. Electrical and electronic items contain materials and substances which, if handled or disposed of incorrectly, could potentially be hazardous to the environment and human health.



## National Television and Computer Recycling Scheme

The careful disposal of e-waste is important because many televisions and computers contain materials which are hazardous to people and the environment. There are no fees for householders or small businesses disposing of e-waste at a scheme collection service.

Individuals can contact their local council for information on local e-waste management services, find scheme services listed on Planet Ark's website at [www.recyclingnearyou.com.au](http://www.recyclingnearyou.com.au), or call Planet Ark on 1300 733 712.

## Compliance

This product complies with the Australian Safety Standard AS/NZS 62368.1 to ensure the safety of the product.





# BAUHN®

## Warranty Information

The product is guaranteed to be free from defects in workmanship and parts for a period of 12 months from the date of purchase. Defects that occur within this warranty period, under normal use and care, will be repaired, replaced or refunded at our discretion, solely at our option with no charge for parts and labour. The benefits conferred by this warranty are in addition to all rights and remedies in respect of the product that the consumer has under the Competition and Consumer Act 2010 and similar state and territory laws.

Our goods come with guarantees that cannot be excluded under the Australian Consumer Law. You are entitled to a replacement or refund for a major failure and to compensation for any other reasonably foreseeable loss or damage. You are also entitled to have the goods repaired or replaced if the goods fail to be of acceptable quality and the failure does not amount to a major failure.





## Repair and Refurbished Goods or Parts Notice

Unfortunately, sometimes faulty products are manufactured, which need to be returned to the supplier for repair.

Please be aware that if your product is capable of retaining user-generated data (such as files stored on a computer hard drive, telephone numbers stored on a mobile telephone, songs stored on a portable media player, games saved on a games console or files stored on a USB memory stick) during the process of repair, some or all of your stored data may be lost. We recommend you save this data elsewhere prior to sending the product for repair.

You should also be aware that rather than repairing goods, we may replace them with refurbished goods of the same type or use refurbished parts in the repair process.

Please be assured though, refurbished parts or replacements are only used where they meet ALDI's stringent quality specifications.

If at any time you feel your repair is being handled unsatisfactorily, you may escalate your complaint. Please telephone us on 1300 886 649 or write to us at:

Tempo (Aust) Pty Ltd ABN 70 106 100 252  
PO Box 6056, Frenchs Forest, NSW 2086, Australia  
Telephone: 1300 886 649 (Aust) - Fax: (02) 8977 3765  
Tempo Help Desk: 1300 886 649 (Aust)  
(Operating Hours: Mon-Fri 8:30am-6pm; Sat 9am-6pm AEST)  
Email: [info@tempo.org](mailto:info@tempo.org)

# Notes



## Online support

Visit [www.bauhn.com.au](http://www.bauhn.com.au) for software updates to keep your TV up-to-date, as well as the latest User Manual for information on the updated features.

## Warranty returns

Should you for any reason need to return this product for a warranty claim, make sure to include all accessories with the product.

## Product does not work?

If you encounter problems with this product, or if it fails to perform to your expectations, please contact our After Sales Support Centre on 1300 886 649 before returning it to the store for a refund.